

VACON®NXL
AC DRIVES

**MULTI-CONTROL
APPLICATION MANUAL**

ES Escalator & Elevator Parts
www.es-escalatorpart.com

VACON MULTI-CONTROL APPLICATION (SOFTWARE ALFIFF20) VER. 3.45

INDEX

1.	Introduction	2
2.	Control I/O	3
3.	Multi-Control Application – Parameter lists	4
3.1	Monitoring values (Control keypad: menu M1).....	4
3.2	Basic parameters (Control keypad: Menu P2 → P2.1).....	5
3.3	Input signals (Control keypad: Menu P2 → P2.2)	7
3.4	Output signals (Control keypad: Menu P2 → P2.3)	9
3.5	Drive control parameters (Control keypad: Menu P2 → P2.4).....	10
3.6	Prohibit frequency parameters (Control keypad: Menu P2 → P2.5)	10
3.7	Motor control parameters (Control keypad: Menu P2 → P2.6)	11
3.8	Protections (Control keypad: Menu P2 → P2.7)	12
3.9	Autorestart parameters (Control keypad: Menu P2 → P2.8).....	13
3.10	PID reference parameters (Control keypad: Menu P2 → P2.9).....	13
3.11	Pump & Fan control parameters (Control keypad: Menu P2 → P2.10).....	14
3.12	Keypad control (Control keypad: Menu K3)	15
3.13	System menu (Control keypad: Menu S6).....	15
3.14	Expander boards (Control keypad: Menu E7)	15
4.	Description of parameters	16
4.1	BASIC PARAMETERS.....	16
4.2	INPUT SIGNALS	21
4.3	OUTPUT SIGNALS.....	25
4.4	DRIVE CONTROL.....	28
4.5	PROHIBIT FREQUENCIES.....	33
4.6	MOTOR CONTROL.....	34
4.7	PROTECTIONS.....	37
4.8	AUTO RESTART PARAMETERS	45
4.9	PID REFERENCE PARAMETERS	46
4.10	PUMP AND FAN CONTROL	52
4.11	KEYPAD CONTROL PARAMETERS	60
5.	Control signal logic in Multi-Control Application.....	62

NOTE! You can download the English and French product manuals with applicable safety, warning and caution information from www.vacon.com/downloads.

REMARQUE Vous pouvez télécharger les versions anglaise et française des manuels produit contenant l'ensemble des informations de sécurité, avertissements et mises en garde applicables sur le site www.vacon.com/downloads.

Multicontrol Application

1. INTRODUCTION

The Multicontrol Application for Vacon NXL uses direct frequency reference from the analogue input 1 as a default. However, a PID controller can be used e.g. in pump and fan applications, which offers versatile internal measuring and adjusting functions.

The direct frequency reference can be used for the control without the PID controller and it can be selected from the analogue inputs, fieldbus, keypad, preset speeds or motor potentiometer.

Special parameters for Pump and Fan Control (**Group P2.10**) can be browsed and edited after changing the value of [par 2.9.1](#) to 2 (Pump and fan control activated).

The PID controller reference can be selected from the analogue inputs, fieldbus, PID keypad reference 1 or by enabling the PID keypad reference 2 via digital input. The PID controller actual value can be selected from the analogue inputs, fieldbus or the actual values of the motor. PID controller can also be used when the frequency converter is controlled via fieldbus or the control keypad.

- Digital inputs DIN2, DIN3, (DIN4) and optional dig. inputs DIE1, DIE2, DIE3 are freely programmable.
- Internal and optional digital/relay and analogue outputs are freely programmable.
- Analogue input 1 can be programmed as current input, voltage input or **digital input DIN4**.

NOTE! If the analogue input 1 has been programmed as DIN4 with [parameter 2.2.6](#) (AI1 Signal Range), check that the jumper selections (Figure 1- 1) are correct.

Additional functions:

- The PID controller can be used from control places I/O, keypad and fieldbus
- Identification
- Programming wizard
- Sleep function
- Actual value supervision function: fully programmable; off, warning, fault
- Programmable Start/Stop and Reverse signal logic
- Reference scaling
- 2 Preset speeds
- Analogue input range selection, signal scaling, inversion and filtering
- Frequency limit supervision
- Programmable start and stop functions
- DC-brake at start and stop
- Prohibit frequency area
- Programmable U/f curve and U/f optimisation
- Adjustable switching frequency
- Autorestart function after fault
- Protections and supervisions (all fully programmable; off, warning, fault):

- Current input fault
- External fault
- Output phase
- Under voltage
- Earth fault

- Motor thermal, stall and underload protection
- Thermistor
- Fieldbus communication
- Option board

2. CONTROL I/O

Reference potentiometer

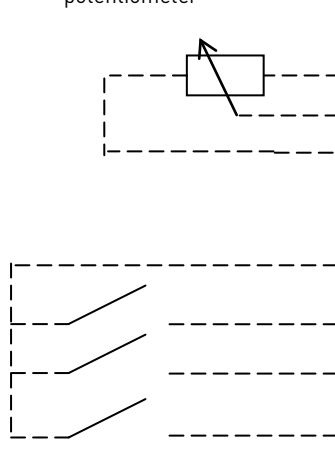

mA

Terminal	Signal	Description
1	+10V _{ref}	Reference output
2	AI1+	Analogue input, voltage range 0–10V DC.
3	AI1-	I/O Ground
4	AI2+	Analogue input, voltage range 0–10V DC, or current range 0/4–20mA
5	AI2- /GND	
6	+24V	Control voltage output
7	GND	I/O ground
8	DIN1	Start forward
9	DIN2	Start reverse (programmable)
10	DIN3	Multi-step speed selection 1 (programmable)
11	GND	I/O ground
18	A01+	Output frequency
19	A01-	Analogue output
A	RS 485	Serial bus
B	RS 485	Serial bus
30	+24V	24V aux. input voltage
21	RO1	Relay output 1 FAULT
22	RO1	
23	RO1	

Table 1- 1. Multicontrol application default I/O configuration.



Terminal	Signal	Description
1	+10V _{ref}	Reference output
2	AI1+ or DIN 4	Analogue input, voltage range 0–10V DC
3	AI1-	I/O Ground
4	AI2+	Analogue input, current range 0–20mA
5	AI2- /GND	
6	+ 24 V	Control voltage output
7	GND	I/O ground

Table 1- 2. AI1 configuration, when programmed as DIN4

3. PARAMETER LISTS

On the next pages you will find the lists of parameters within the respective parameter groups. The parameter descriptions are given on pages 16 to 46.

Column explanations:

Code	=	Location indication on the keypad; Shows the operator the present param. number
Parameter	=	Name of parameter
Min	=	Minimum value of parameter
Max	=	Maximum value of parameter
Unit	=	Unit of parameter value; Given if available
Default	=	Value preset by factory
Cust	=	Customer's own setting
ID	=	ID number of the parameter (used with PC tools)
	=	On the parameter code: parameter value can only be changed after the FC has been stopped.

3.1 Monitoring values (Control keypad: menu M1)

The monitoring values are the actual values of parameters and signals as well as statuses and measurements. Monitoring values cannot be edited.

See Vacon NXL User's Manual, Chapter 7.4.1 for more information.

Code	Parameter	Unit	ID	Description
V1.1	Output frequency	Hz	1	Frequency to the motor
V1.2	Frequency reference	Hz	25	
V1.3	Motor speed	rpm	2	Calculated motor speed
V1.4	Motor current	A	3	Measured motor current
V1.5	Motor torque	%	4	Calculated actual torque/nom. torque of the motor
V1.6	Motor power	%	5	Calculated actual power/nom. power of the motor
V1.7	Motor voltage	V	6	Calculated motor voltage
V1.8	DC-link voltage	V	7	Measured DC-link voltage
V1.9	Unit temperature	°C	8	Heat sink temperature
V1.10	Analogue Input 1		13	AI1
V1.11	Analogue input 2		14	AI2
V1.12	Analogue output current	mA	26	AO1
V1.13	Analogue output current 1, expander board	mA	31	
V1.14	Analogue output current 2, expander board	mA	32	
V1.15	DIN1, DIN2, DIN3		15	Digital input statuses
V1.16	DIE1, DIE2, DIE3		33	I/O expander board: Digital input statuses
V1.17	RO1		34	Relay output 1 status
V1.18	ROE1, ROE2, ROE3		35	I/O exp. board: Relay output statuses
V1.19	DOE 1		36	I/O exp. board: Digital output 1 status
V1.20	PID Reference	%	20	In percent of the maximum process reference
V1.21	PID Actual value	%	21	In percent of the maximum actual value
V1.22	PID Error value	%	22	In percent of the maximum error value
V1.23	PID Output	%	23	In percent of the maximum output value
V1.24	Autochange outputs 1, 2, 3		30	Used only in pump and fan control
V1.25	Mode		66	Shows current operation mode selected with startup wizard: 0 =Not selected, 1 =Standard, 2 =Fan, 3 =Pump, 4 =High Performance
V1.26	Motor temperature	%	9	Calculated motor temperature, 1000 equals 100.0% = nominal temperature of motor

Table 1- 3. Monitoring values

3.2 Basic parameters (Control keypad: Menu P2 → P2.1)

Code	Parameter	Min	Max	Unit	Default	Cust	ID	Note
P2.1.1	Min frequency	0,00	Par. 2.1.2	Hz	0,00		101	
P2.1.2	Max frequency	Par. 2.1.1	320,00	Hz	50,00		102	NOTE: If f_{max} > than the motor synchronous speed, check suitability for motor and drive system
P2.1.3	Acceleration time 1	0,1	3000,0	s	1,0		103	
P2.1.4	Deceleration time 1	0,1	3000,0	s	1,0		104	
P2.1.5	Current limit	$0,1 \times I_L$	$1,5 \times I_L$	A	I_L		107	NOTE: Formulas apply approximately for frequency converters up to MF3. For greater sizes, consult the factory.
P2.1.6	Nominal voltage of the motor	180	690	V	NXL2:230v NXL5:400v		110	
P2.1.7	Nominal frequency of the motor	30,00	320,00	Hz	50,00		111	Check the rating plate of the motor
P2.1.8	Nominal speed of the motor	300	20 000	rpm	1440		112	The default applies for a 4-pole motor and a nominal size frequency converter.
P2.1.9	Nominal current of the motor	$0,3 \times I_L$	$1,5 \times I_L$	A	I_H		113	Check the rating plate of the motor
P2.1.10	Motor cosφ	0,30	1,00		0,85		120	Check the rating plate of the motor
P2.1.11	Start function	0	2		0		505	0=Ramp 1=Flying start 2=Conditional flying start
P2.1.12	Stop function	0	1		0		506	0=Coasting 1=Ramp
P2.1.13	U/f optimisation	0	1		0		109	0=Not used 1=Automatic torque boost
P2.1.14	I/O reference	0	5		0		117	0=AI1 1=AI2 2=Keypad reference 3=Fieldbus reference (FBSpeedReference) 4=Motor potentiometer 5=AI1/AI2 selection
P2.1.15	AI2 signal range	1	4		2		390	Not used if AI2 Custom min <> 0% or AI2 custom max. <> 100% 1=0—20 mA 2=4—20 mA 3=0V - 10V 4=2V - 10V
P2.1.16	Analogue output function	0	12		1		307	0=Not used 1=Output freq. (0— f_{max}) 2=Freq. reference (0— f_{max}) 3=Motor speed (0—Motor nominal speed) 4=Output current (0— I_{nMotor}) 5=Motor torque (0— T_{nMotor}) 6=Motor power (0— P_{nMotor}) 7=Mot. voltage (0— U_{nMotor}) 8=DC-link volt (0—1000V) 9=PI controller ref. value 10=PI contr. act. value 1 11=PI contr. error value 12=PI controller output

P2.1.17	DIN2 function	0	10		1	319	0=Not used 1=Start Reverse (DIN1=Start forward) 2=Reverse (DIN1=Start) 3=Stop pulse (DIN1=Start pulse) 4=External fault, cc 5=External fault, oc 6=Run enable 7=Preset speed 2 8= Motor pot. UP (cc) 9= Disable PID (Direct freq. reference) 10=Interlock 1
P2.1.18	DIN3 function	0	17		6	301	0=Not used 1=Reverse 2=External fault, cc 3=External fault, oc 4=Fault reset 5=Run enable 6=Preset speed 1 7=Preset speed 2 8=DC-braking command 9=Motor pot. UP (cc) 10=Motor pot. DOWN (cc) 11=Disable PID (Direct freq. reference) 12=PID Keypad ref. 2 selection 13=Interlock 2 14=Thermistor input Note! See NXL User's Manual, Chapter 6.2.4 15= Force cp to I/O 16= Force cp to Fieldbus 17=AI1/AI2 selection for I/O reference
P2.1.19	Preset speed 1	0,00	Par. 2.1.2	Hz	10,00	105	
P2.1.20	Preset speed 2	0,00	Par. 2.1.2	Hz	50,00	106	
P2.1.21	Automatic restart	0	1		0	731	0=Not used 1=Used
P2.1.22	Parameter conceal	0	1		0	115	0=All parameters and menus visible 1=Only group P2.1 and menus M1 to H5 visible

Table 1- 4. Basic parameters P2.1

CP= control place

3.3 Input signals (Control keypad: Menu P2 → P2.2)

Code	Parameter	Min	Max	Unit	Default	Cust	ID	Note
P2.2.1	Expander board DIE1 function	0	13		7		368	0=Not used 1=Reverse 2=External fault, cc 3=External fault, oc 4=Fault reset 5=Run enable 6=Preset speed 1 7=Preset speed 2 8=DC-braking command 9=Motor pot. UP (cc) 10=Motor pot. DOWN (cc) 11=Disable PID (PID control selection) 12=PID Keypad ref. 2 selection 13=Interlock 1
P2.2.2	Expander board DIE2 function	0	13		4		330	As par. 2.2.1, except: 13=Interlock 2
P2.2.3	Expander board DIE3 function	0	13		11		369	As par. 2.2.1, except: 13=Interlock 3
P2.2.4	DIN4 function (AI1)	0	13		2		499	Used if P2.2.6 = 0 Selections as in par.2.2.3
P2.2.5	AI1 signal selection	0			10		377	10=AI1 (1=Local, 0=input 1) 11=AI2 (1=Local, 1= input 2) 20=Exp. AI1 (2=exp.board 0=input 1) 21=Exp AI2 (2=exp.board 1=input 2)
P2.2.6	AI1 signal range	1	4		3		379	0=Digital input 4 1=0mA – 20mA (MF4-->) 2=4mA – 20mA (MF4-->) 3=0V – 10V 4=2V – 10V Not used if AI2 Custom min > 0% or AI2 custom max. < 100% Note! See NXL User's manual, chapter 7.4.6: AI1 mode
P2.2.7	AI1 custom minimum setting	0,00	100,00	%	0,00		380	
P2.2.8	AI1 custom maximum setting	0,00	100,00	%	100,00		381	
P2.2.9	AI1 inversion	0	1		0		387	0=Not inverted 1=Inverted
P2.2.10	AI1 filter time	0,00	10,00	s	0,10		378	0=No filtering
P2.2.11	AI2 signal selection	0			11		388	As par. 2.2.5
P2.2.12	AI2 signal range	1	4		2		390	Not used if AI2 Custom min <> 0% or AI2 custom max. <> 100% 1=0–20 mA 2=4–20 mA 3=0V – 10V 4=2V – 10V

P2.2.13	AI2 custom minimum setting	0,00	100,00	%	0,00		391	
P2.2.14	AI2 custom maximum setting	0,00	100,00	%	100,00		392	
P2.2.15	AI2 inversion	0	1		0		398	0=Not inverted 1=Inverted
P2.2.16	AI2 filter time	0,00	10,00	s	0,10		389	0=No filtering
P2.2.17	Motor potentiometer frequency reference memory reset	0	2		1		367	0=No reset 1=Reset if stopped or powered down 2=Reset if powered down
P2.2.18	Reference scaling minimum value	0,00	P2.2.19		0,00		344	Does not affect the fieldbus reference (Scaled between par. 2.1.1 and par. 2.1.2)
P2.2.19	Reference scaling maximum value	P2.2.18	320,00		0,00		345	Does not affect the fieldbus reference (Scaled between par. 2.1.1 and par. 2.1.2)
P2.2.20	Keypad control reference selection	0	5		2		121	0=A11 1=A12 2=Keypad reference 3=Fieldbus reference (FBSpeedreference) 4=Motor potentiometer 5=PID controller
P2.2.21	Fieldbus control reference selection	0	5		3		122	See above

Table 1- 5. Input signals, P2.2

CP=control place
cc=closing contact
oc=opening contact

3.4 Output signals (Control keypad: Menu P2 → P2.3)

Code	Parameter	Min	Max	Unit	Default	Cust	ID	Note
P2.3.1	Relay output 1 function	0	20		3		313	0=Not used 1=Ready 2=Run 3=Fault 4=Fault inverted 5=FC overheat warning 6=Ext. fault or warning 7=Ref. fault or warning 8=Warning 9=Reversed 10=Preset speed 11=At speed 12=Mot. regulator active 13=OP freq. limit superv.1 14=Control place: IO 15=Thermistor fault/ warning 16=Actual value supervision 17=Autochange 1 control 18=Autochange 2 control 19=Autochange 3 control 20=AI supervision
P2.3.2	Expander board relay output 1 function	0	19		2		314	As parameter 2.3.1
P2.3.3	Expander board relay output 2 function	0	19		3		317	As parameter 2.3.1
P2.3.4	Expander board digital output 1 function	0	19		1		312	As parameter 2.3.1
P2.3.5	Analogue output function	0	12		1		307	See par. 2.1.16
P2.3.6	Analogue output filter time	0,00	10,00	s	1,00		308	0=No filtering
P2.3.7	Analogue output inversion	0	1		0		309	0=Not inverted 1=Inverted
P2.3.8	Analogue output minimum	0	1		0		310	0=0 mA 1=4 mA
P2.3.9	Analogue output scale	10	1000	%	100		311	
P2.3.10	Expander board analogue output 1 function	0	12		0		472	As parameter 2.1.16
P2.3.11	Expander board analogue output 2 function	0	12		0		479	As parameter 2.1.16
P2.3.12	Output frequency limit 1 supervision	0	2		0		315	0=No limit 1=Low limit supervision 2=High limit supervision
P2.3.13	Output frequency limit 1; Supervised value	0,00	Par. 2.1.2	Hz	0,00		316	
P2.3.14	Analogue input supervision	0	2		0		356	0=Not used 1=AI1 2=AI2
P2.3.15	AI supervision OFF limit	0,00	100,00	%	10,00		357	
P2.3.16	AI supervision ON limit	0,00	100,00	%	90,00		358	
P2.3.17	Relay output 1 ON delay	0,00	320,00	s	0,00		487	ON delay for RO1
P2.3.18	Relay output 1 OFF delay	0,00	320,00	s	0,00		488	OFF delay for RO1

Table 1- 6. Output signals, G2.3

3.5 Drive control parameters (Control keypad: Menu P2 → P2.4)

Code	Parameter	Min	Max	Unit	Default	Cust	ID	Note
P2.4.1	Ramp 1 shape	0,0	10,0	s	0,0		500	0=Linear >0=S-curve ramp time
P2.4.2	Brake chopper	0	3		0		504	0=Disabled 1=Used in Run state 3=Used in Run and Stop state
P2.4.3	DC braking current	$0,15 \times I_n$	$1,5 \times I_n$	A	Varies		507	
P2.4.4	DC braking time at stop	0,00	600,00	s	0,00		508	0=DC brake is off at stop
P2.4.5	Frequency to start DC braking during ramp stop	0,10	10,00	Hz	1,50		515	
P2.4.6	DC braking time at start	0,00	600,00	s	0,00		516	0=DC brake is off at start
P2.4.7	Flux brake	0	1		0		520	0=Off 1=On
P2.4.8	Flux braking current	0,0	Varies	A	0,0		519	

Table 1- 7. Drive control parameters, P2.4

3.6 Prohibit frequency parameters (Control keypad: Menu P2 → P2.5)

Code	Parameter	Min	Max	Unit	Default	Cust	ID	Note
P2.5.1	Prohibit frequency range 1 low limit	0,0	Par. 2.5.2	Hz	0,0		509	0=Not used
P2.5.2	Prohibit frequency range 1 high limit	0,0	Par. 2.1.2	Hz	0,0		510	0=Not used
P2.5.3	Prohibit frequencies acc./dec. ramp scaling	0,1	10,0	Times	1,0		518	Multiplier of the currently selected ramp time between prohibit frequency limits

Table 1- 8. Prohibit frequency parameters, P2.5

3.7 Motor control parameters (Control keypad: Menu P2 → P2.6)

Code	Parameter	Min	Max	Unit	Default	Cust	ID	Note
P2.6.1	Motor control mode	0	1		0		600	0=Frequency control 1=Speed control
P2.6.2	U/f ratio selection	0	3		0		108	0=Linear 1=Squared 2=Programmable 3=Linear with flux optim.
P2.6.3	Field weakening point	30,00	320,00	Hz	50,00		602	
P2.6.4	Voltage at field weakening point	10,00	200,00	%	100,00		603	$n\% \times U_{n\text{mot}}$
P2.6.5	U/f curve midpoint frequency	0,00	par. P2.6.3	Hz	50,00		604	
P2.6.6	U/f curve midpoint voltage	0,00	100,00	%	100,00		605	$n\% \times U_{n\text{mot}}$ Parameter max. value = par. 2.6.4
P2.6.7	Output voltage at zero frequency	0,00	40,00	%	0,00		606	$n\% \times U_{n\text{mot}}$
P2.6.8	Switching frequency	1,0	16,0	kHz	6,0		601	Depends on kW
P2.6.9	Overvoltage controller	0	1		1		607	0=Not used 1=Used
P2.6.10	Undervoltage controller	0	1		1		608	0=Not used 1=Used
P2.6.11	Identification	0	1		0		631	0=No action 1=ID no run

Table 1- 9. Motor control parameters, P2.6

3.8 Protections (Control keypad: Menu P2 → P2.7)

Code	Parameter	Min	Max	Unit	Default	Cust	ID	Note
P2.7.1	Response to 4mA reference fault	0	3		0		700	0=No response 1=Warning 2=Fault,stop acc. to 2.1.12 3=Fault,stop by coasting
P2.7.2	Response to external fault	0	3		2		701	0=No response 1=Warning 2=Fault,stop acc. to 2.1.12 3=Fault,stop by coasting
P2.7.3	Response to undervoltage fault	1	3		2		727	
P2.7.4	Output phase supervision	0	3		2		702	
P2.7.5	Earth fault protection	0	3		2		703	
P2.7.6	Thermal protection of the motor	0	3		2		704	
P2.7.7	Motor ambient temperature factor	-100,0	100,0	%	0,0		705	
P2.7.8	Motor cooling factor at zero speed	0,0	150,0	%	40,0		706	
P2.7.9	Motor thermal time constant	1	200	min	45		707	
P2.7.10	Motor duty cycle	0	100	%	100		708	
P2.7.11	Stall protection	0	3		1		709	As par. 2.7.1
P2.7.12	Stall current limit	0,1	$I_{n\text{motor}} \times 2$	A	$I_{n\text{motor}} \times 1.3$		710	
P2.7.13	Stall time limit	1,00	120,00	s	15,00		711	
P2.7.14	Stall frequency limit	1,0	P 2.1.2	Hz	25,0		712	
P2.7.15	Underload protection	0	3		0		713	As par. 2.7.1
P2.7.16	Underload curve at nominal frequency	10,0	150,0	%	50,0		714	
P2.7.17	Underload curve at zero frequency	5,0	150,0	%	10,0		715	
P2.7.18	Underload protection time limit	2,00	600,00	s	20,00		716	
P2.7.19	Response to thermistor fault	0	3		2		732	As par. 2.7.1
P2.7.20	Response to fieldbus fault	0	3		2		733	As par. 2.7.1
P2.7.21	Response to slot fault	0	3		2		734	As par. 2.7.1
P2.7.22	Actual value supervision	0	4		0		735	0=No response 1=Warning if below limit 2=Warning if above limit 3=Fault, if below limit 4=Fault, if above limit
P2.7.23	Actual value supervision limit	0,0	100,0	%	10,0		736	
P2.7.24	Actual value supervision delay	0	3600	s	5		737	

Table 1- 10. Protections, P2.7

3.9 Autorestart parameters (Control keypad: Menu P2 → P2.8)

Code	Parameter	Min	Max	Unit	Default	Cust	ID	Note
P2.8.1	Wait time	0,10	10,00	s	0,50		717	
P2.8.2	Trial time	0,00	60,00	s	30,00		718	
P2.8.3	Start function	0	2		0		719	0=Ramp 1=Flying start 2=According to par. 2.4.6

Table 1- 11. Autorestart parameters, P2.8

3.10 PID reference parameters (Control keypad: Menu P2 → P2.9)

Code	Parameter	Min	Max	Unit	Default	Cust	ID	Note
P2.9.1	PID activation	0	1		0		163	0=Not used 1=PID controller activated 2=Pump & fan control active, group P2.10 visible
P2.9.2	PID reference	0	3		2		332	0=A11 1=A12 2=Ref. from keypad (PID Ref 1) 3=Fieldbus reference (ProcessDataIN1)
P2.9.3	Actual value input	0	7		1		334	0=A11 signal 1=A12 signal 2=Fieldbus (ProcessDataIN2) 3=Motor torque 4=Motor speed 5=Motor current 6=Motor power 7=A11-A12
P2.9.4	PID controller gain	0,0	1000,0	%	100,0		118	
P2.9.5	PID controller I-time	0,00	320,00	s	10,00		119	
P2.9.6	PID controller D-time	0,00	10,00	s	0,00		132	
P2.9.7	Actual value 1 minimum scale	-1000,0	1000,0	%	0,00		336	0=No minimum scaling
P2.9.8	Actual value 1 maximum scale	-1000,0	1000,0	%	100,0		337	100=No maximum scaling
P2.9.9	Error value inversion	0	1		0		340	
P2.9.10	Sleep frequency	Par. 2.1.1	Par. 2.1.2	Hz	10,00		1016	
P2.9.11	Sleep delay	0	3600	s	30		1017	
P2.9.12	Wake up level	0,00	100,00	%	25,00		1018	
P2.9.13	Wake up function	0	3		0		1019	0=Wake-up at fall below wake-up level (2.9.12) 1=Wake-up at exceeded wake-up level (2.9.12) 2=Wake-up at fall below wake up level (PID ref) 3=Wake-up at exceeded wake up level (PID ref)

Table 1- 12. PID reference parameters, P2.9

3.11 Pump & Fan control parameters (Control keypad: Menu P2 → P2.10)

NOTE! Group P2.10 is visible only if the value of [par 2.9.1](#) is set to 2.

Code	Parameter	Min	Max	Unit	Default	Cust	ID	Note
P2.10.1	Number of auxiliary drives	0	3		1		1001	
P2.10.2	Start delay, auxiliary drives	0,0	300,0	s	4,0		1010	
P2.10.3	Stop delay, auxiliary drives	0,0	300,0	s	2,0		1011	
P2.10.4	Autochange	0	4		0		1027	0=Not used 1= Autochange with aux pumps 2= Autochange with Freq. conv & aux pumps 3= Autochange and interlocks (aux pumps) 4= Autochange and interlocks (Freq. conv & aux pumps)
P2.10.5	Autochange interval	0,0	3000,0	h	48,0		1029	0,0=TEST=40 s Elapsed time for autochange
P2.10.6	Autochange; Maximum number of auxiliary drives	0	3		1		1030	Autochange level for auxiliary drives
P2.10.7	Autochange frequency limit	0,00	par. 2.1.2	Hz	25,00		1031	Autochange frequency level for variable speed drive
P2.10.8	Start frequency, auxiliary drive 1	Par. 2.10.9	320,00	Hz	51,00		1002	
P2.10.9	Stop frequency, auxiliary drive 1	Par. 2.1.1	Par. 2.10.8	Hz	10,00		1003	

Table 1- 13. Pump and fan control parameters, P2.10

3.12 Keypad control (Control keypad: Menu K3)

The parameters for the selection of control place and direction on the keypad are listed below. See the Keypad control menu in the Vacon NXL User's Manual.

Code	Parameter	Min	Max	Unit	Default	Cust	ID	Note
P3.1	Control place	1	3		1		125	1 = I/O terminal 2 = Keypad 3 = Fieldbus
R3.2	Keypad reference	Par. 2.1.1	Par. 2.1.2	Hz				
P3.3	Direction (on keypad)	0	1		0		123	0 = Forward 1 = Reverse
R3.4	Stop button	0	1		1		114	0=Limited function of Stop button 1=Stop button always enabled
R3.5	PID reference	0,00	100,00	%	0,00			
R3.6	PID reference 2	0,00	100,00	%	0,00			Selected with digital inputs

Table 1- 14. Keypad control parameters, M3

3.13 System menu (Control keypad: Menu S6)

For parameters and functions related to the general use of the frequency converter, such as customised parameter sets or information about the hardware and software, see Chapter 7.4.6 in the Vacon NXL User's Manual.

3.14 Expander boards (Control keypad: Menu E7)

The E7 menu shows the expander boards attached to the control board and board-related information. For more information, see Chapter 7.4.7 in the Vacon NXL User's Manual.

4. DESCRIPTION OF PARAMETERS

4.1 BASIC PARAMETERS

2.1.1, 2.1.2 *Minimum/maximum frequency*

Defines the frequency limits of the frequency converter.

The maximum value for parameters 2.1.1 and 2.1.2 is 320 Hz.

The software will automatically check the values of parameters [2.1.19](#), [2.1.20](#), [2.3.13](#), [2.5.1](#), [2.5.2](#) and [2.6.5](#).

2.1.3, 2.1.4 *Acceleration time 1, deceleration time 1*

These limits correspond to the time required for the output frequency to accelerate from the zero frequency to the set maximum frequency (par. 2.1.2).

2.1.5 *Current limit*

This parameter determines the maximum motor current from the frequency converter. To avoid motor overload, set this parameter according to the rated current of the motor. The current limit is equal to the rated converter current (I_L) by default.

2.1.6 *Nominal voltage of the motor*

Find this value U_n on the rating plate of the motor. This parameter sets the voltage at the field weakening point ([parameter 2.6.4](#)) to $100\% \times U_{n\text{motor}}$.

2.1.7 *Nominal frequency of the motor*

Find this value f_n on the rating plate of the motor. This parameter sets the field weakening point ([parameter 2.6.3](#)) to the same value.

2.1.8 *Nominal speed of the motor*

Find this value n_n on the rating plate of the motor.

2.1.9 *Nominal current of the motor*

Find this value I_n on the rating plate of the motor.

2.1.10 *Motor cos phi*

Find this value "cos phi" on the rating plate of the motor.

2.1.11 Start function

Ramp:

- 0 The frequency converter starts from 0 Hz and accelerates to maximum frequency within the set [acceleration time](#). (Load inertia or starting friction may cause prolonged acceleration times).

Flying start:

- 1 The frequency converter is able to start into a running motor by applying a small torque to motor and searching for the frequency corresponding to the speed the motor is running at. The searching starts from the maximum frequency towards the actual frequency until the correct value is detected. Thereafter, the output frequency will be increased/decreased to the set reference value according to the set acceleration/deceleration parameters.

Use this mode if the motor is coasting when the start command is given. With the flying start, it is possible to ride through short mains voltage interruptions.

Conditional flying start

- 2 With this mode it is possible to disconnect and connect the motor from the frequency converter even when the Start command is active. On re-connecting the motor, the drive will operate as described in selection 1

2.1.12 Stop function

Coasting:

- 0 The motor coasts to a halt without control from the frequency converter after the Stop command.

Ramp:

- 1 After the Stop command, the speed of the motor is decelerated according to the set deceleration parameters.

If the regenerated energy is high it may be necessary to use an external braking resistor for faster deceleration.

2.1.13 *U/f optimisation*

0 Not used

1 **Automatic torque boost**

The voltage to the motor changes automatically which makes the motor produce sufficient torque to start and run at low frequencies. The voltage increase depends on the motor type and power. Automatic torque boost can be used in applications where starting torque due to starting friction is high, e.g. in conveyors.

NOTE! *In high torque – low speed applications – it is likely that the motor will overheat. If the motor has to run a prolonged time under these conditions, special attention must be paid to cooling the motor. Use external cooling for the motor if the temperature tends to rise too high.*

2.1.14 *I/O Reference selection*

Defines the selected frequency reference source when the drive is controlled from the I/O terminal.

0 AI1 reference (terminals 2 and 3, e.g. potentiometer)

1 AI2 reference (terminals 5 and 6, e.g. transducer)

2 Keypad reference (parameter 3.2)

3 Reference from Fieldbus (FBSpeedReference)

4 Motor potentiometer reference

5 AI1/AI2 selection. Selection of AI2 is made programmable by DIN3 Function ([P2.1.18](#))

2.1.15 *AI2 (I_{in}) signal range*

1 Signal range 0...20 mA

2 Signal range 4...20 mA

3 Signal range 0...10V

4 Signal range 2...10V

Note! The selections have no effect if par. 2.2.12 > 0%, or par. 2.2.13 < 100%.

2.1.16 *Analogue output function*

This parameter selects the desired function for the analogue output signal. See the table on page 5 for the parameter values.

2.1.17 *DIN2 function*

This parameter has 10 selections. If digital input DIN2 need not be used, set the parameter value to 0.

- 1 Start reverse
- 2 Reverse
- 3 Stop pulse
- 4 External fault
Contact closed: Fault is displayed and motor stopped when the input is active
- 5 External fault
Contact open: Fault is displayed and motor stopped when the input is not active
- 6 Run enable
Contact open: Start of motor disabled
Contact closed: Start of motor enabled
Coast stop if dropped during RUN
- 7 Preset speed 2
- 8 Motor potentiometer UP
Contact closed: Reference increases until the contact is opened.
- 9 Disable the PID-controller (Direct frequency reference)
- 10 Interlock 1 (can only be selected, when pump and fan control is active, [P2.9.1=2](#))

2.1.18 *DIN3 function*

The parameter has 13 selections. If digital input DIN3 need not be used, set the param. value to 0.

- 1 Reverse
Contact open: Forward
Contact closed: Reverse
- 2 External fault
Contact closed: Fault is displayed and motor stopped when the input is active
- 3 External fault
Contact open: Fault is displayed and motor stopped when the input is not active
- 4 Fault reset
Contact closed: All faults reset
- 5 Run enable
Contact open: Start of motor disabled
Contact closed: Start of motor enabled
Coast stop if dropped during RUN
- 6 Preset speed 1
- 7 Preset speed 2
- 8 DC braking command
Contact closed: In Stop mode, the DC braking operates until the contact is opened. DC-braking current is about 10% of the value selected with [par. 2.4.3](#).
- 9 Motor potentiometer UP
Contact closed: Reference increases until the contact is opened.
- 10 Motor potentiometer DOWN.
Contact closed: Reference decreases until the contact is opened
- 11 Disable the PID-controller (Direct frequency reference)
- 12 PID Keypad reference 2 selection
- 13 Interlock 2 (can only be selected, when pump and fan control is active, [P2.9.1=2](#))
- 14 Thermistor input **NOTE! See NXL User's Manual, Chapter 6.2.4**
- 15 Force control place to I/O
- 16 Force control place to Fieldbus
- 17 AI1/AI2 selection for I/O Reference ([par 2.1.14](#))

2.1.19 *Preset speed 1***2.1.20** *Preset speed 2*

Parameter values are automatically limited between the minimum and maximum frequencies. (par. 2.1.1 and 2.1.2)

2.1.21 *Automatic restart function*

The automatic restart is taken into use with this parameter

0 = Disabled

1 = Enabled (3 automatic restarts, see par. 2.8.1 – 2.8.3)

2.1.22 *Parameter conceal*

With this parameter you can hide all other parameter groups except the basic parameter group (B2.1).

The factory default of this parameter is 0.

0 = Disabled (all parameter groups can be browsed with the keypad)

1 = Enabled (only the basic parameters, B2.1, can be browsed with the keypad)

ES Escalator & Elevator Parts
www.es-escalatorpart.com

4.2 INPUT SIGNALS

2.2.1 Expander board DIE1 function

This parameter has 12 selections. If the expander board digital input DIN1 need not be used, set the parameter value to 0.

Selections are as in [parameter 2.1.18](#), except:

13 = Interlock 1

2.2.2 Expander board DIE2 function

The selections are the same as in parameter 2.2.1, except:

13 = Interlock 2

2.2.3 Expander board DIE3 function

The selections are the same as in parameter 2.2.1.

13 = Interlock 3

2.2.4 DIN4 Function

If the value of [par. 2.2.6](#) is set to 0, AI1 functions as digital input 4.

The selections are the same as in parameter 2.2.3.

NOTE! If you program the analogue input as DIN4 check that the jumper selections are correct (see figure below).

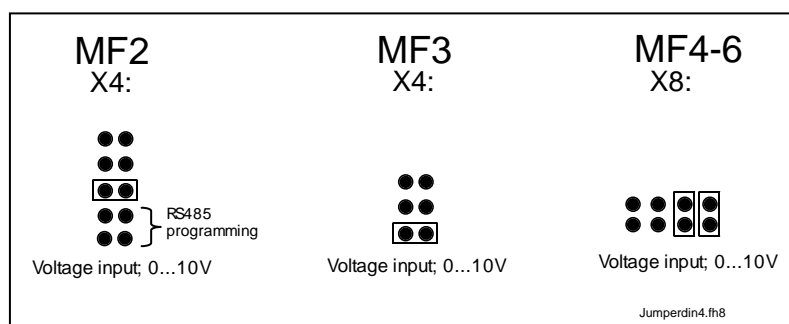

Figure 1- 1. Jumper selections of X4/X8 when AI1 functions as DIN4

2.2.5 AI1 signal selection

Connect the AI1 signal to the analogue input of your choice with this parameter.

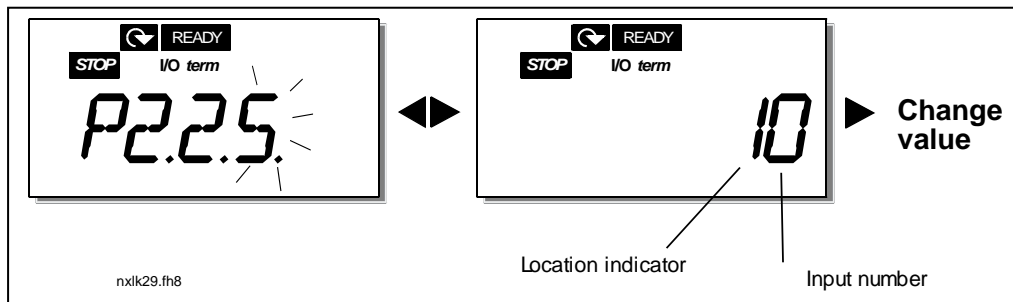

Figure 1- 2. AI1 signal selection

The value of this parameter is formed of the *board indicator* and the *respective input terminal number*. See Figure 1- 2 above.

Board indicator 1	= Local inputs
Board indicator 2	= Expander board inputs
Input number 0	= Input 1
Input number 1	= Input 2
Input number 2	= Input 3
⋮	
Input number 9	= Input 10

Example:

If you set the value of this parameter to **10**, you have selected the local input **1** for the AI1 signal. Again, if the value is set to **21**, the expander board input **2** has been selected for the AI1 signal.

If you want to use the values of analogue input signal for e.g. testing purposes only, you can set the parameter value to **0 - 9**. In this case, value **0** corresponds to **0%**, value **1** corresponds to **20%** and any value between **2** and **9** corresponds to **100%**.

2.2.6 AI1 signal range

With this parameter you can select the AI1 signal range.

- 0 = DIN 4
- 1 = Signal range 0...20mA (only for sizes MF4 and bigger)
- 2 = Signal range 4...20mA (only for sizes MF4 and bigger)
- 3 = Signal range 0...10V
- 4 = Signal range 2...10V

Note! The selections have no effect if par. 2.2.7 > 0%, or par. 2.2.8 < 100%.

If the value of par. 2.2.6 is set to **0**, AI1 functions as digital input 4. See par. 2.2.4

2.2.7 *AI1 custom setting minimum***2.2.8** *AI1 custom setting maximum*

Set the custom minimum and maximum levels for the AI1 signal within 0...10V.

2.2.9 *AI1 signal inversion*

By setting the parameter value to 1 the AI1 signal inversion takes place.

2.2.10 *AI1 signal filter time*

This parameter, given a value greater than 0, activates the function that filters out disturbances from the incoming analogue U_{in} signal.

Long filtering time makes the regulation response slower. See Figure 1- 3

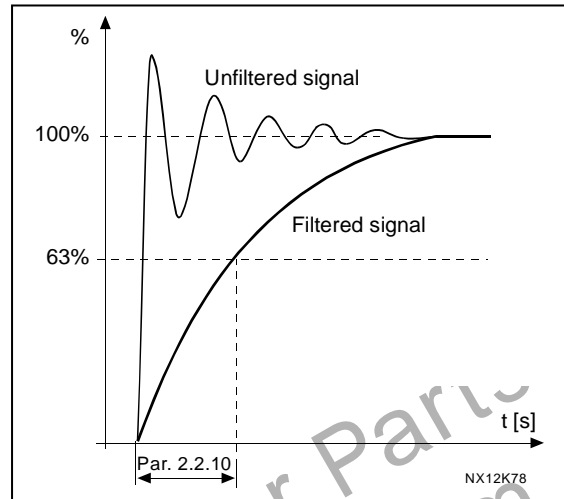

Figure 1- 3. AI1 signal filtering

2.2.11 *AI2 signal selection*

Connect the AI2 signal to the analogue input of your choice with this parameter. See [par. 2.2.5](#) for the value setting procedure.

2.2.12 *AI2 signal range*

1 = Signal range 0...20mA

2 = Signal range 4...20mA

3 = Signal range 0...10V

4 = Signal range 2...10V

Note! The selections have no effect if [par. 2.2.13](#) > 0%, or [par. 2.2.14](#) < 100%.

2.2.13 *AI2 custom minimum***2.2.14** *AI2 custom maximum*

These parameters allow you to scale the input current signal between 0 and 20 mA.

Cf. parameters [2.2.7](#) and [2.2.8](#).

2.2.15 *Analogue input AI2 signal inversion*

See corresponding parameter [2.2.9](#).

2.2.16 *Analogue input AI2 signal filter time*

See corresponding parameter [2.2.10](#).

2.2.17 *Motor potentiometer memory reset (Frequency reference)*

0 = No reset

1 = Memory reset in stop and powerdown

2 = Memory reset in powerdown

2.2.18 *Reference scaling minimum value*

2.2.19 *Reference scaling maximum value*

You can choose a scaling range for the frequency reference between the [Minimum](#) and [Maximum](#) frequency. If no scaling is desired set the parameter value to 0.

In the figures below, voltage input AI1 with signal range 0...10V is selected for reference.

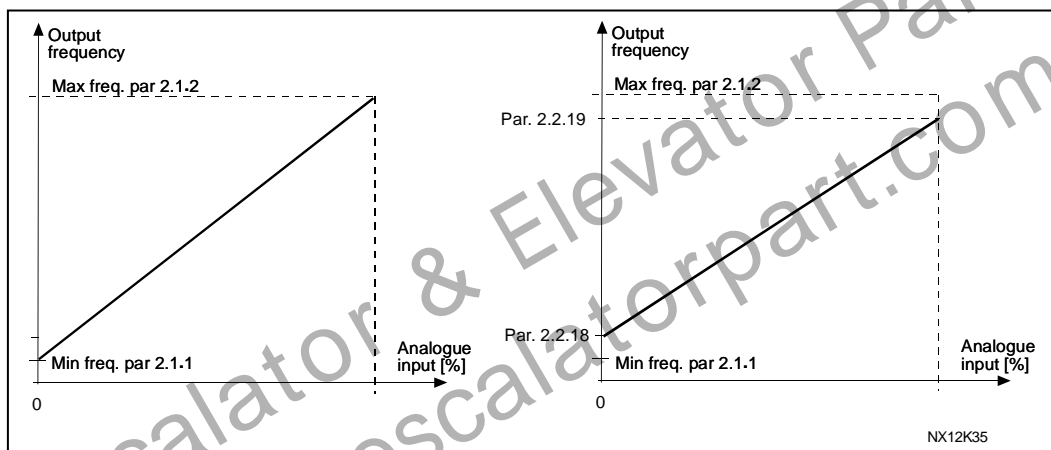

Figure 1-4. Left: Par. 2.2.18=0 (No reference scaling) Right: Reference scaling

2.2.20 *Keypad frequency reference selection*

Defines the selected reference source when the drive is controlled from the keypad

0 AI1 reference (by default AI1, terminals 2 and 3, e.g. potentiometer)

1 AI2 reference (by default AI2, terminals 5 and 6, e.g. transducer)

2 Keypad reference (parameter 3.2)

3 Reference from Fieldbus (FBSpeedReference)

4 Motor potentiometer reference

5 PID-controller reference

2.2.21 *Fieldbus frequency reference selection*

Defines the selected reference source when the drive is controlled from the fieldbus.

For the parameter values, see [par. 2.2.20](#).

4.3 OUTPUT SIGNALS

2.3.1 Relay output 1 function

2.3.2 Expander board relay output 1 function

2.3.3 Expander board relay output 2 function

2.3.4 Expander board digital output 1 function

Setting value	Signal content
0 = Not used	Out of operation
	<u>Relay output R01 and expander board programmable relays (R01, R02) are activated when:</u>
1 = Ready	The frequency converter is ready to operate
2 = Run	The frequency converter operates (motor is running)
3 = Fault	A fault trip has occurred
4 = Fault inverted	A fault trip <u>not</u> occurred
5 = Frequency converter overheat warning	The heat-sink temperature exceeds +70°C
6 = External fault or warning	Fault or warning depending on par. 2.7.2
7 = Reference fault or warning	Fault or warning depending on par. 2.7.1 - if analogue reference is 4–20 mA and signal is <4mA
8 = Warning	Always if a warning exists
9 = Reversed	The reverse command has been selected
10 = Preset speed	A preset speed has been selected
11 = At speed	The output frequency has reached the set reference
12 = Motor regulator activated	Overvoltage or overcurrent regulator was activated
13 = Output frequency limit 1 supervision	The output frequency goes outside the set supervision low limit/high limit (see parameters 2.3.12 and 2.3.13 below)
14 = Control from I/O terminals	Selected control place (Menu K3 ; par. 3.1) is "I/O terminal"
15 = Thermistor fault or warning	The thermistor input of option board indicates overtemperature. Fault or warning depending on parameter 2.7.19 .
16 = Actual value supervision active	Parameters 2.7.22 – 2.7.24
17 = Autochange 1 control	Pump 1 control, parameters 2.10.1 – 2.10.7
18 = Autochange 2 control	Pump 2 control, parameters 2.10.1 – 2.10.7
19 = Autochange 3 control	Pump 3 control, parameters 2.10.1 – 2.10.7
20 = AI supervision	The relay energizes according to settings of parameters 2.3.14 – 2.3.16 .

Table 1- 15. Output signals via R01 and expander board R01, R02 and DO1.

2.3.5 Analogue output function

This parameter selects the desired function for the analogue output signal.

See the table on page 5 for the parameter values.

2.3.6 Analogue output filter time

Defines the filtering time of the analogue output signal.

If you set value **0** for this parameter, no filtering takes place.

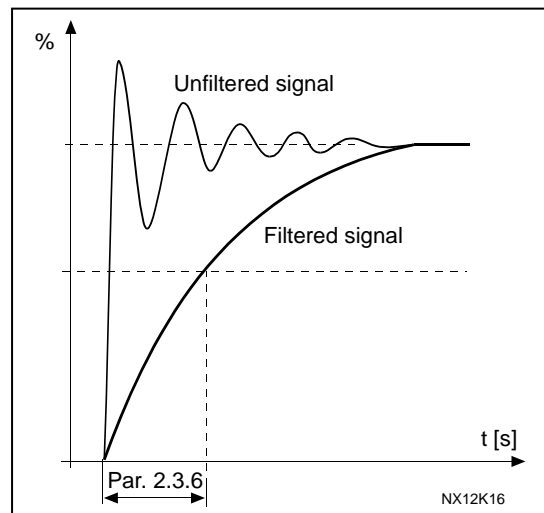

Figure 1- 5. Analogue output filtering

2.3.7 Analogue output invert

Inverts the analogue output signal:

Maximum output signal = 0 %

Minimum output signal = Maximum set value (parameter 2.3.9)

- 0 Not inverted
- 1 Inverted

See parameter 2.3.9 below.

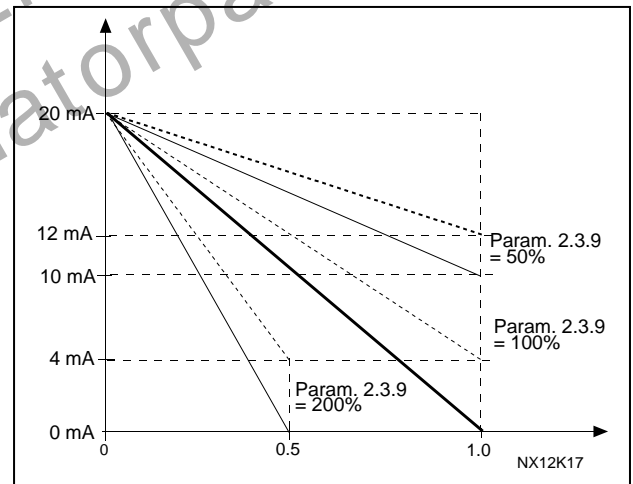

Figure 1- 6. Analogue output invert

2.3.8 Analogue output minimum

Sets the signal minimum to either 0 mA or 4 mA (living zero). Note the difference in the analogue output scaling in parameter 2.3.9.

2.3.9 Analogue output scale

Scaling factor for the analogue output.

Signal	Max. value of the signal
Output frequency	100% x f_{max}
Motor speed	100% x Motor nom. speed
Output current	100% x I_{nMotor}
Motor torque	100% x T_{nMotor}
Motor power	100% x P_{nMotor}
Motor voltage	100% x U_{nMotor}
DC-link voltage	1000 V
PI-ref. value	100% x ref. value max.
PI act. value 1	100% x actual value max.
PI error value	100% x error value max.
PI output	100% x output max.

Table 1- 16. Analogue output scaling

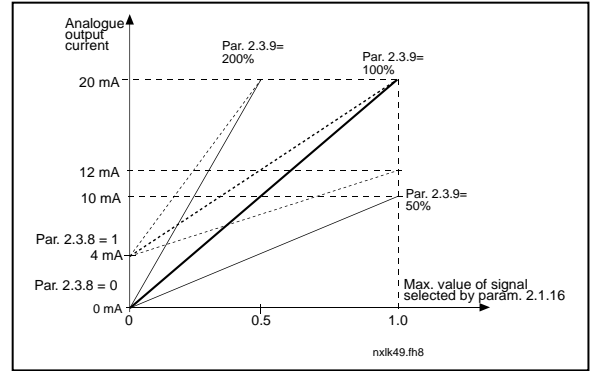

Figure 1- 7. Analogue output scaling

2.3.10 Expander board analogue output 1 function

2.3.11 Expander board analogue output 2 function

These parameters select the desired functions for the expander board analogue output signals. See [par. 2.1.16](#) for the parameter values.

2.3.12 Output frequency limit 1 supervision function

- 0 No supervision
- 1 Low limit supervision
- 2 High limit supervision

If the output frequency goes under/over the set limit ([par. 2.3.13](#)) this function generates a warning message via the relay outputs depending on the settings of parameters [2.3.1](#) – [2.3.4](#).

2.3.13 Output frequency limit 1 supervised value

Selects the frequency value supervised by parameter 2.3.12.

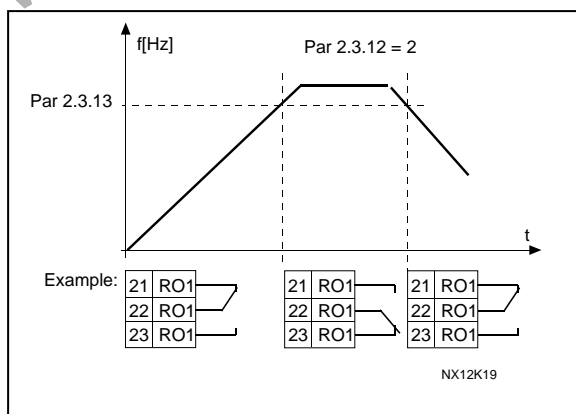

Figure 1- 8. Output frequency supervision

2.3.14 *Analogue input supervision*

With this parameter you can select the analogue input to be supervised.

0 = Not used

1 = AI1

2 = AI2

2.3.15 *Analogue input supervision OFF limit*

When the signal of analogue input selected with par. 2.3.14 falls under the limit set with this parameter, the relay output goes off.

2.3.16 *Analogue input supervision ON limit*

When the signal of analogue input selected with par. 2.3.14 goes over the limit set with this parameter, the relay output goes on.

This means that if for example ON limit is 60% and OFF limit is 40%, the relay goes on when signal goes over 60% and remains on until it falls under 40%.

2.3.17 *Relay output 1 ON delay*

2.3.18 *Relay output 1 OFF delay*

With these parameters you can set on- and off-delays to relay output 1 ([par 2.3.1](#)).

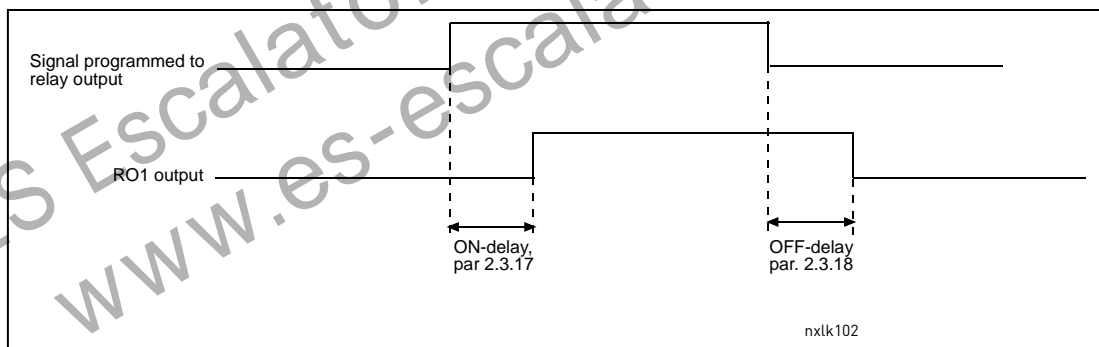

Figure 1- 9. Relay output 1 on- and off-delays

4.4 DRIVE CONTROL

2.4.1 Acceleration/Deceleration ramp 1 shape

The start and end of the acceleration and deceleration ramp can be smoothed with this parameter. Setting value 0 gives a linear ramp shape which causes acceleration and deceleration to act immediately to the changes in the reference signal.

Setting value 0.1...10 seconds for this parameter produces an S-shaped acceleration/deceleration. The acceleration time is determined with parameters [2.1.3/2.1.4](#)

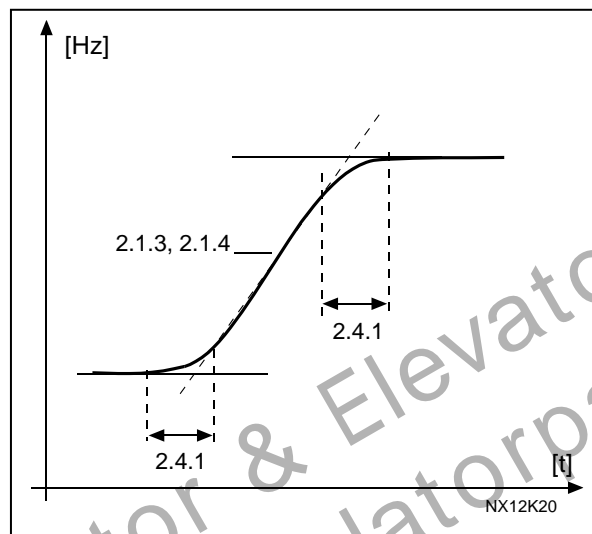

Figure 1-10. Acceleration/Deceleration (S-shaped)

2.4.2 Brake chopper

Note! An internal brake chopper is installed in all other sizes but MF2

- 0 No brake chopper used
- 1 Brake chopper used in Run state
- 3 Used in Run and Stop state

When the frequency converter is decelerating the motor, the inertia of the motor and the load are fed into an external brake resistor. This enables the frequency converter to decelerate the load with a torque equal to that of acceleration (provided that the correct brake resistor has been selected). See separate Brake resistor installation manual.

2.4.3 DC-braking current

Defines the current injected into the motor during DC-braking.

2.4.4 DC-braking time at stop

Determines if braking is ON or OFF and the braking time of the DC-brake when the motor is stopping. The function of the DC-brake depends on the stop function, [parameter 2.1.12](#).

- 0 DC-brake is not used
- >0 DC-brake is in use and its function depends on the Stop function, ([par. 2.1.12](#)). The DC-braking time is determined with this parameter

Par. 2.1.12 = 0 (Stop function = Coasting):

After the stop command, the motor coasts to a stop without control from the frequency converter.

With the DC injection, the motor can be electrically stopped in the shortest possible time, without using an optional external braking resistor.

The braking time is scaled by the frequency when the DC-braking starts. If the frequency is greater than the nominal frequency of the motor, the set value of parameter 2.4.4 determines the braking time. When the frequency is $\leq 10\%$ of the nominal, the braking time is 10% of the set value of parameter 2.4.4.

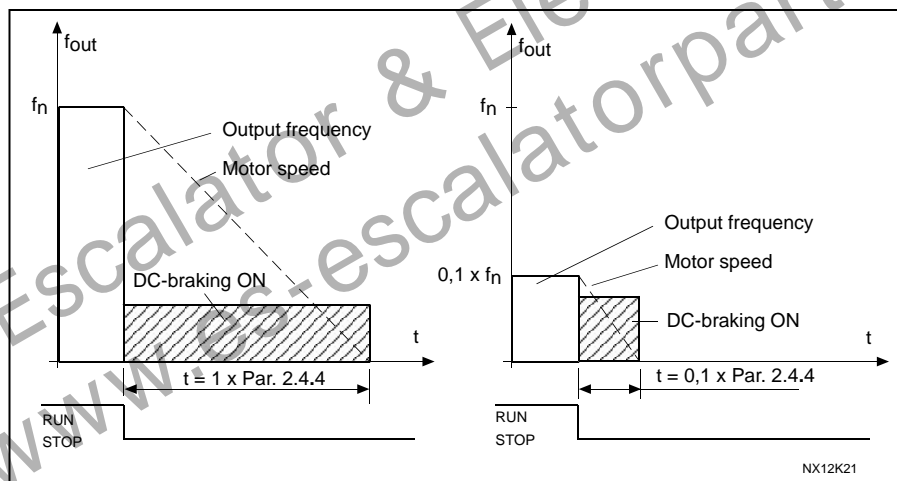

Figure 1- 11. DC-braking time when Stop mode = Coasting.

Par. 2.1.12 = 1 (Stop function = Ramp):

After the Stop command, the speed of the motor is reduced according to the set deceleration parameters, as fast as possible, to the speed defined with parameter 2.4.5, where the DC-braking starts.

The braking time is defined with parameter 2.4.4. If high inertia exists, it is recommended to use an external braking resistor for faster deceleration. See Figure 1- 12.

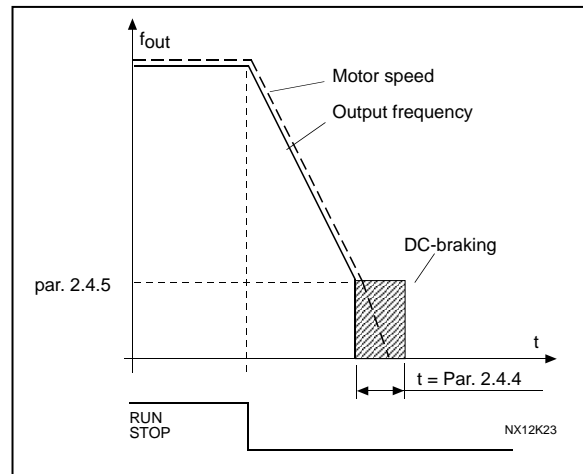

Figure 1- 12. DC-braking time when Stop mode = Ramp

2.4.5 DC-braking frequency in ramp stop

The output frequency at which the DC-braking is applied. See Figure 1- 12.

2.4.6 DC-braking time at start

DC-brake is activated when the start command is given. This parameter defines the time before the brake is released. After the brake is released, the output frequency increases according to the set start function by parameter 2.1.11. See Figure 1- 13.

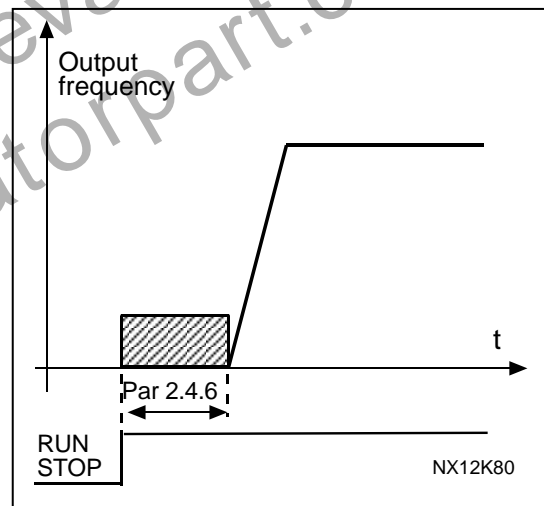

Figure 1- 13. DC braking time at start

2.4.7 Flux brake

Instead of DC braking, flux braking is a useful form of braking with motors $\leq 15\text{kW}$.

When braking is needed, the frequency is reduced and the flux in the motor is increased, which in turn increases the motor's capability to brake. Unlike DC braking, the motor speed remains controlled during braking

The flux braking can be set ON or OFF.

0 = Flux braking OFF

1 = Flux braking ON

Note: Flux braking converts the energy into heat at the motor, and should be used intermittently to avoid motor damage

2.4.8 *Flux braking current*

Defines the flux braking current value. It can be set between $0.3 \times I_H$ (approximately) and the [Current limit](#).

ES Escalator & Elevator Parts
www.es-escalatorpart.com

4.5 PROHIBIT FREQUENCIES

2.5.1 *Prohibit frequency area 1; Low limit*

2.5.2 *Prohibit frequency area 1; High limit*

In some systems it may be necessary to avoid certain frequencies because of mechanical resonance problems. With these parameters it is possible to set a limit for the "skip frequency" region. See Figure 1- 14.

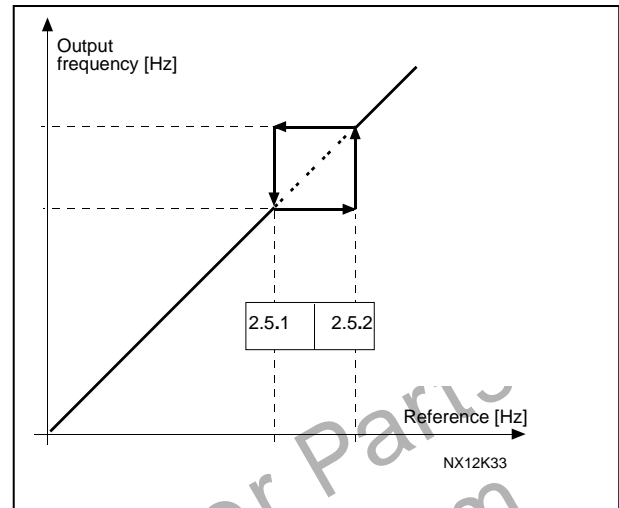

Figure 1- 14. Prohibit frequency area setting.

2.5.3 *Acceleration/deceleration ramp speed scaling ratio between prohibit frequency limits*

Defines the acceleration/deceleration time when the output frequency is between the selected prohibit frequency range limits (parameters 2.5.1 and 2.5.2). The ramping time (selected acceleration/ deceleration time 1 or 2) is multiplied with this factor. E.g. value 0.1 makes the acceleration time 10 times shorter than outside the prohibit frequency range limits.

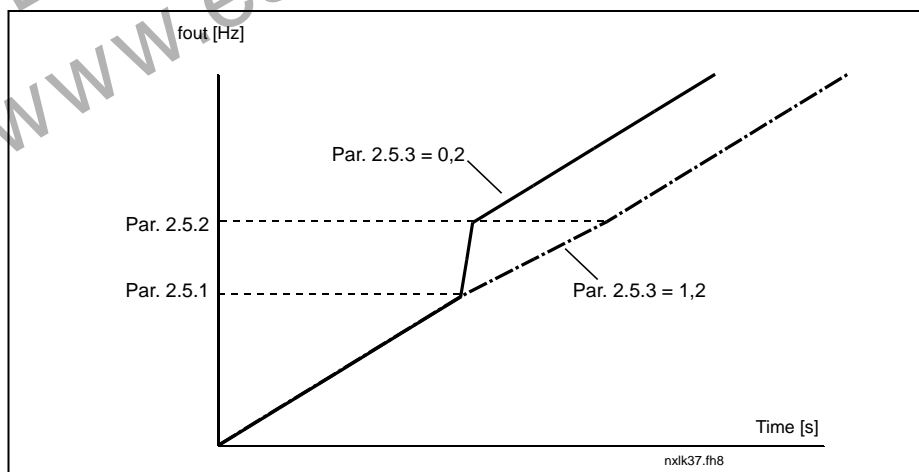

Figure 1- 15. Ramp time scaling between prohibit frequencies

4.6 MOTOR CONTROL

2.6.1 Motor control mode

- 0 Frequency control: The I/O terminal and keypad references are frequency references and the frequency converter controls the output frequency (output frequency resolution = 0.01 Hz)
- 1 Speed control: The I/O terminal and keypad references are speed references and the frequency converter controls the motor speed (accuracy $\pm 0,5\%$).

2.6.2 U/f ratio selection

Linear: The voltage of the motor changes linearly with the frequency in the constant flux area from 0 Hz to the field weakening point where the nominal voltage is supplied to the motor. Linear U/f ratio should be used in constant torque applications. See Figure 1- 16.

0

This default setting should be used if there is no special need for another setting.

Squared: The voltage of the motor changes following a squared curve form with the frequency in the area from 0 Hz to the field weakening point where the nominal voltage is also supplied to the motor. The motor runs under magnetised below the field weakening point and produces less torque and electromechanical noise. Squared U/f ratio can be used in applications where torque demand of the load is proportional to the square of the speed, e.g in centrifugal fans and pumps.

1

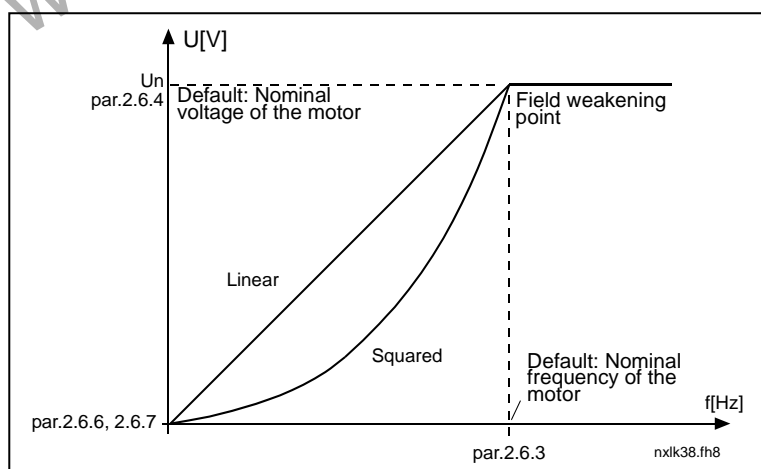

Figure 1- 16. Linear and squared change of motor voltage

Programmable U/f curve:

- The U/f curve can be programmed with three different points. Programmable U/f curve can be used if the other settings do not satisfy the needs of the application.

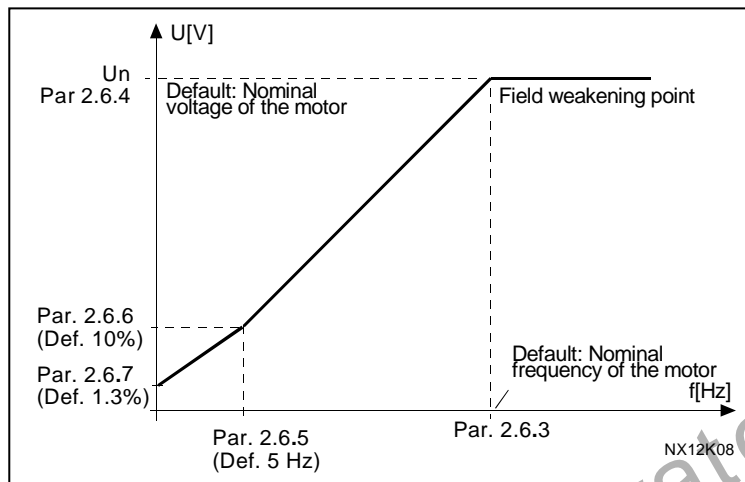

Figure 1- 17. Programmable U/f curve

Linear with flux optimisation:

- The frequency converter starts to search for the minimum motor current and in order to save energy, lower the disturbance level and the noise. Can be used in applications with constant motor load, such as fans, pumps etc.

2.6.3 Field weakening point

The field weakening point is the output frequency at which the output voltage reaches the value set with par. 2.6.4.

2.6.4 Voltage at field weakening point

Above the frequency at the field weakening point, the output voltage remains at the value set with this parameter. Below the frequency at the field weakening point, the output voltage depends on the setting of the U/f curve parameters. See parameters [2.1.13](#), [2.6.2](#), [2.6.5](#), [2.6.6](#) and [2.6.7](#) and Figure 1- 17.

When the parameters [2.1.6](#) and [2.1.7](#) (nominal voltage and nominal frequency of the motor) are set, the parameters 2.6.3 and 2.6.4 are automatically given the corresponding values. If you need different values for the field weakening point and the voltage, change these parameters **after** setting the parameters 2.1.6 and 2.1.7.

2.6.5 U/f curve, middle point frequency

If the programmable U/f curve has been selected with parameter [2.6.2](#) this parameter defines the middle point frequency of the curve. See Figure 1- 17.

2.6.6 *U/f curve, middle point voltage*

If the programmable U/f curve has been selected with the parameter 2.6.2 this parameter defines the middle point voltage of the curve. See Figure 1- 17.

2.6.7 *Output voltage at zero frequency*

This parameter defines the zero frequency voltage of the curve. See Figure 1- 17.

2.6.8 *Switching frequency*

Motor noise can be minimised using a high switching frequency. Increasing the switching frequency reduces the capacity of the frequency converter unit.

Switching frequency for Vacon NXL: 1...16 kHz

2.6.9 *Overvoltage controller*

2.6.10 *Undervoltage controller*

These parameters allow the under-/overvoltage controllers to be switched out of operation. This may be useful, for example, if the mains supply voltage varies more than -15% to +10% and the application will not tolerate this over-/undervoltage. This regulator controls the output frequency taking the supply fluctuations into account.

Note: Over-/undervoltage trips may occur when controllers are switched out of operation.

- 0 Controller switched off
- 1 Controller switched on

2.6.11 *Identification*

- 0 No action
- 1 ID no run

When ID no run is selected, the drive will perform an ID-run when it is started from selected control place. Drive has to be started within 20 seconds, otherwise identification is aborted.

The drive does not rotate the motor during ID no run. When ID run is ready the drive is stopped. Drive will start normally, when the next start command is given.

The ID run improves the torque calculations and the automatic torque boost function. It will also result in a better slip compensation in speed control (more accurate RPM)

4.7 PROTECTIONS

2.7.1 *Response to 4mA reference fault*

- 0 = No response
- 1 = Warning
- 2 = Fault, stop mode after fault according to [parameter 2.1.12](#)
- 3 = Fault, stop mode after fault always by coasting

A warning or a fault action and message is generated if the 4...20 mA reference signal is used and the signal falls below 3.5 mA for 5 seconds or below 0.5 mA for 0.5 seconds. The information can also be programmed into relay outputs.

2.7.2 *Response to external fault*

- 0 = No response
- 1 = Warning
- 2 = Fault, stop mode after fault according to [parameter 2.1.12](#)
- 3 = Fault, stop mode after fault always by coasting

A warning or a fault action and message is generated from the external fault signal in the programmable digital inputs. The information can also be programmed into relay outputs.

2.7.3 *Response to undervoltage fault*

- 1 = Warning
- 2 = Fault, stop mode after fault according to [parameter 2.1.12](#)
- 3 = Fault, stop mode after fault always by coasting

For the undervoltage limits see Vacon NXL, User's Manual, Table 4-3.

Note: This protection can not be inactivated.

2.7.4 *Output phase supervision*

- 0 = No response
- 1 = Warning
- 2 = Fault, stop mode after fault according to [parameter 2.1.12](#)
- 3 = Fault, stop mode after fault always by coasting

Output phase supervision of the motor ensures that the motor phases have an approximately equal current.

2.7.5 *Earth fault protection*

- 0 = No response
- 1 = Warning
- 2 = Fault, stop mode after fault according to [parameter 2.1.12](#)
- 3 = Fault, stop mode after fault always by coasting

Earth fault protection ensures that the sum of the motor phase currents is zero. The overcurrent protection is always working and protects the frequency converter from earth faults with high currents.

Parameters 2.7.6—2.7.10, Motor thermal protection:

General

The motor thermal protection is to protect the motor from overheating. The Vacon drive is capable of supplying higher than nominal current to the motor. If the load requires this high current there is a risk that the motor will be thermally overloaded. This is the case especially at low frequencies. At low frequencies the cooling effect of the motor is reduced as well as its capacity. If the motor is equipped with an external fan the load reduction at low speeds is small.

The motor thermal protection is based on a calculated model and it uses the output current of the drive to determine the load on the motor.

The motor thermal protection can be adjusted with parameters. The thermal current I_T specifies the load current above which the motor is overloaded. This current limit is a function of the output frequency.



CAUTION! *The calculated model does not protect the motor if the airflow to the motor is reduced by blocked air intake grill.*

2.7.6 *Motor thermal protection*

- 0 = No response
- 1 = Warning
- 2 = Fault, stop mode after fault according to [parameter 2.1.12](#)
- 3 = Fault, stop mode after fault always by coasting

If tripping is selected the drive will stop and activate the fault stage.

Deactivating the protection, i.e. setting parameter to 0, will reset the thermal model of the motor to 0%.

Motor overtemperature sensing is required if the parameter is set to 0.

2.7.7 Motor thermal protection: Motor ambient temperature factor

When the motor ambient temperature must be taken into consideration, it is recommended to set a value for this parameter. The value of the factor can be set between -100.0% and 100.0% where -100.0% corresponds to 0°C and 100.0% to the maximum running ambient temperature of the motor. Setting this parameter value to 0% assumes that the ambient temperature is the same as the temperature of the heatsink at power-on.

2.7.8 Motor thermal protection: Cooling factor at zero speed

The cooling power can be set between $0-150.0\%$ x cooling power at nominal frequency. See Figure 1- 18.

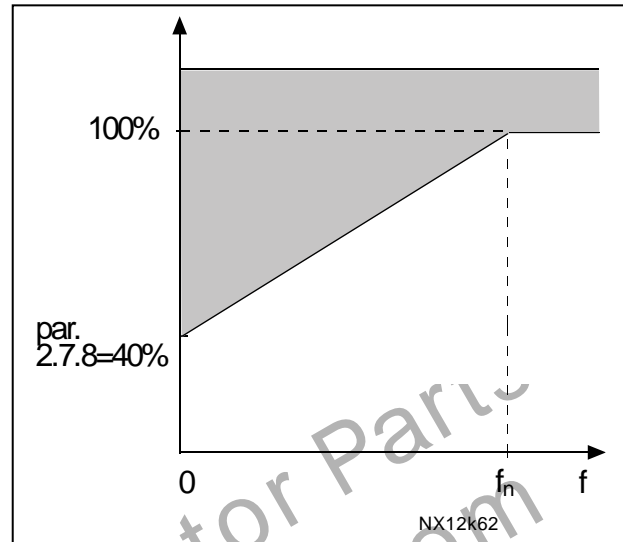

Figure 1- 18. Motor cooling power

2.7.9 Motor thermal protection: Time constant

This time can be set between 1 and 200 minutes.

This is the thermal time constant of the motor. The bigger the motor, the bigger the time constant. The time constant is the time within which the calculated thermal model has reached 63% of its final value.

The motor thermal time is specific to the motor design and it varies between different motor manufacturers.

If the motor's t_6 -time (t_6 is the time in seconds the motor can safely operate at six times the rated current) is known (given by the motor manufacturer) the time constant parameter can be set basing on it. As a rule of thumb, the motor thermal time constant in minutes equals to $2 \times t_6$. If the drive is in stop state the time constant is internally increased to three times the set parameter value. The cooling in the stop state is based on convection and the time constant is increased. See also Figure 1- 19.

Note: If the nominal speed (par. 2.1.8) or the nominal current (par. 2.1.9) of the motor are changed this parameter is automatically set to the default value (45).

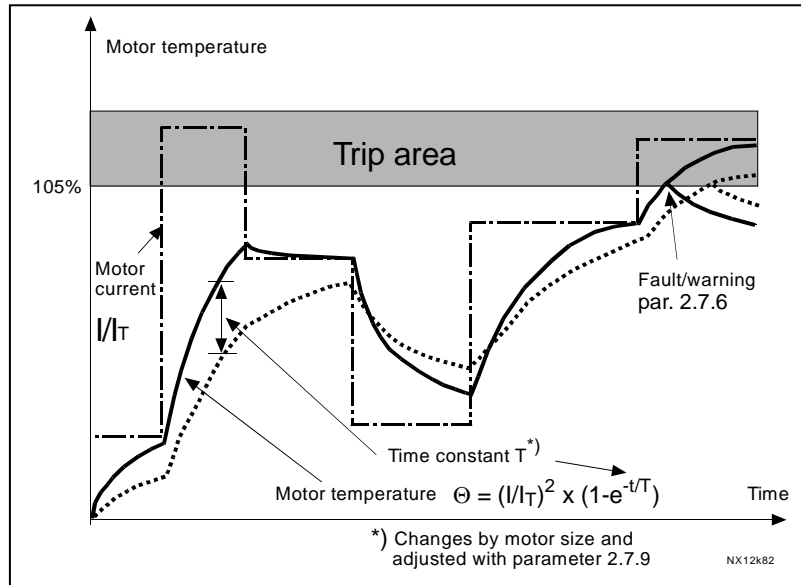

Figure 1- 19. Motor temperature calculation

2.7.10 Motor thermal protection: Motor duty cycle

Defines how much of the nominal motor load is applied.
The value can be set to 0%...100%.

Parameter 2.7.11, Stall protection:

General

The motor stall protection protects the motor from short time overload situations such as one caused by a stalled shaft. The reaction time of the stall protection can be set shorter than that of motor thermal protection. The stall state is defined with two parameters, 2.7.12 (Stall current) and 2.7.13 (Stall frequency). If the current is higher than the set limit and output frequency is lower than the set limit, the stall state is true. There is actually no real indication of the shaft rotation. Stall protection is a type of overcurrent protection.

2.7.11 Stall protection

- 0 = No response
- 1 = Warning
- 2 = Fault, stop mode after fault according to [parameter 2.1.12](#)
- 3 = Fault, stop mode after fault always by coasting

Setting the parameter to 0 will deactivate the protection and reset the stall time counter.

2.7.12 Stall current limit

The current can be set to $0.0 \dots I_{nMotor} * 2$. For a stall stage to occur, the current must have exceeded this limit. See Figure 1- 20. The software does not allow entering a greater value than $I_{nMotor} * 2$. If the [parameter 2.1.9](#) Nominal current of motor is changed, this parameter is automatically restored to the default value ($I_{nMotor} * 1.3$).

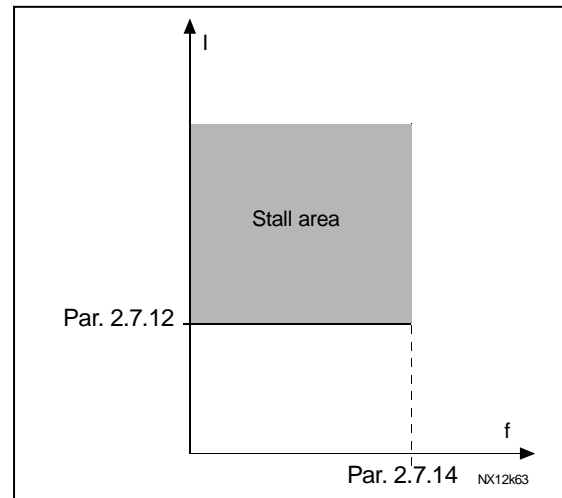

Figure 1- 20. Stall characteristics settings

2.7.13 Stall time

This time can be set between 1.0 and 120.0s.

This is the maximum time allowed for a stall event detection. The stall time is counted by an internal up/down counter. If the stall time counter value goes above this limit the protection will cause a trip (see Figure 1- 21)

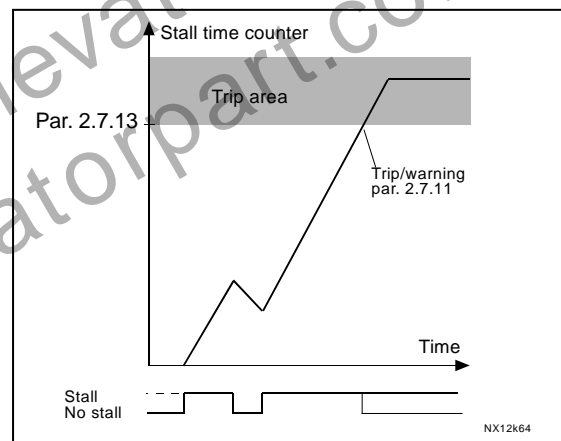

Figure 1- 21. Stall time count

2.7.14 Maximum stall frequency

The frequency can be set between $1-f_{max}$ ([par. 2.1.2](#)).

For a stall event to occur, the output frequency must have remained below this limit.

Parameters 2.7.15—2.7.18, Underload protection:

General

The purpose of the motor underload protection is to ensure that there is load on the motor when the drive is running. If the motor loses its load there might be a problem in the process, e.g. a broken belt or a dry pump.

Motor underload protection can be adjusted by setting the underload curve with parameters 2.7.16 (Field weakening area load) and 2.7.17 (Zero frequency load), see below. The underload curve is a squared curve set between the zero frequency and the field weakening point. The protection is not active below 5 Hz (the underload time counter is stopped).

The torque values for setting the underload curve are set in percentage which refers to the nominal torque of the motor. The motor's name plate data, the parameter Motor nominal current and the drive's nominal current I_L are used to find the scaling ratio for the internal torque value. If other than nominal motor is used with the drive, the accuracy of the torque calculation decreases.

2.7.15 Underload protection

0 = No response

1 = Warning

2 = Fault, stop mode after fault according to [parameter 2.1.12](#)

3 = Fault, stop mode after fault always by coasting

If tripping is set active the drive will stop and activate the fault stage.

Deactivating the protection by setting the parameter to 0 will reset the underload time counter.

2.7.16 Underload protection, field weakening area load

The torque limit can be set between 10.0—150.0 % x T_{nMotor} .

This parameter gives the value for the minimum torque allowed when the output frequency is above the field weakening point. See Figure 1- 22.

If you change the [parameter 2.1.9](#) (Motor nominal current) this parameter is automatically restored to the default value.

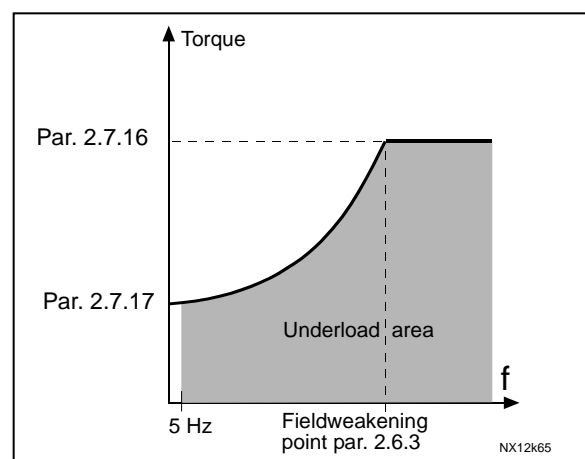

Figure 1- 22. Setting of minimum load

2.7.17 Underload protection, zero frequency load

The torque limit can be set between 5.0—150.0 % x T_{nMotor} .

This parameter gives value for the minimum torque allowed with zero frequency. See Figure 1- 22.

If you change the value of [parameter 2.1.9](#) (Motor nominal current) this parameter is automatically restored to the default value.

2.7.18 Underload time

This time can be set between 2.0 and 600.0 s.

This is the maximum time allowed for an underload state to exist. An internal up/down counter counts the accumulated underload time. If the underload counter value goes above this limit the protection will cause a trip according to [parameter 2.7.15](#). If the drive is stopped the underload counter is reset to zero. See Figure 1- 23.

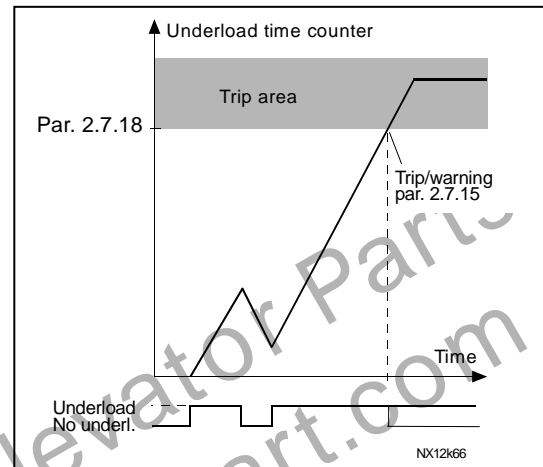

Figure 1- 23. Underload time counter function

2.7.19 Response to thermistor fault

0 = No response

1 = Warning

2 = Fault, stop mode after fault according to [parameter 2.1.12](#)

3 = Fault, stop mode after fault always by coasting

Setting the parameter to 0 will deactivate the protection.

2.7.20 Response to fieldbus fault

Set here the response mode for the fieldbus fault if a fieldbus board is used. For more information, see the respective Fieldbus Board Manual.

See parameter 2.7.19.

2.7.21 Response to slot fault

Set here the response mode for a board slot fault due to missing or broken board.

See parameter 2.7.19.

2.7.22 *Actual value supervision function*

0 = Not used

1 = Warning, if actual value falls below the limit set with par. 2.7.23

2 = Warning, if actual value exceeds the limit set with par. 2.7.23

3 = Fault, if actual value falls below the limit set with par. 2.7.23

4 = Fault, if actual value exceeds the limit set with par. 2.7.23

2.7.23 *Actual value supervision limit*

With this parameter you can set the limit of actual value supervised by par. 2.7.22

2.7.24 *Actual value supervision delay*

Set here the delay for the actual value supervision function (par. 2.7.22)

If this parameter is in use, the function of par. 2.7.22 will be active only when the actual value stays outside the defined limit for the time determined by this parameter.

ES Escalator & Elevator Parts
www.es-escalatorpart.com

4.8 AUTO RESTART PARAMETERS

The automatic restart function is active if the value of [par. 2.1.21](#) = 1. There are always three restart trials

2.8.1 Automatic restart: Wait time

Defines the time before the frequency converter tries to automatically restart the motor after the fault has disappeared.

2.8.2 Automatic restart: Trial time

The Automatic restart function restarts the frequency converter when the faults have disappeared and the waiting time has elapsed.

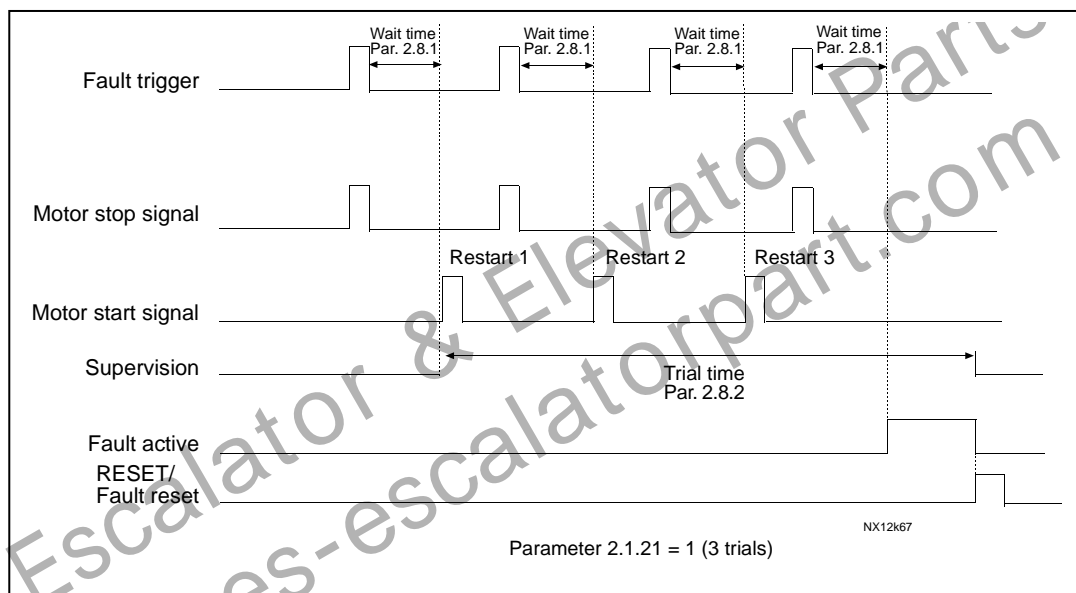

Figure 1- 24. Automatic restart.

The time count starts from the first autorestart. If the number of faults occurring during the trial time exceeds three, the fault state becomes active. Otherwise the fault is cleared after the trial time has elapsed and the next fault starts the trial time count again.

If a single fault remains during the trial time, a fault state is true.

2.8.3 Automatic restart, start function

The Start function for Automatic restart is selected with this parameter. The parameter defines the start mode:

- 0 = Start with ramp
- 1 = Flying start
- 2 = Start according to [par. 2.1.11](#)

4.9 PID REFERENCE PARAMETERS

2.9.1 *PID activation*

With this parameter you can activate or deactivate the PID controller or activate the pump and fan control parameters.

- 0 = PID controller deactivated
- 1 = PID controller activated
- 2 = Pump and fan control activated. Parameter group P2.10 becomes visible.

2.9.2 *PID reference*

Defines which frequency reference source is selected for the PID controller.

Default value is 2.

- 0 = AI1 reference
- 1 = AI2 reference
- 2 = PID reference from the Keypad control page (Group K3, parameter P3.5)
- 3 = Reference from the fieldbus (FBProcessDataIN1)

2.9.3 *Actual value input*

- 0 AI1
- 1 AI2
- 2 Fieldbus (*Actual value 1*: FBProcessDataIN2; *Actual value 2*: FBProcessDataIN3)
- 3 Motor torque
- 4 Motor speed
- 5 Motor current
- 6 Motor power
- 7 AI1 – AI2

2.9.4 *PID controller gain*

This parameter defines the gain of the PID controller. If the value of the parameter is set to 100% a change of 10% in the error value causes the controller output to change by 10%.

If the parameter value is set to 0 the PID controller operates as ID-controller.

See examples below.

2.9.5 PID controller I-time

This parameter defines the integration time of the PID controller. If this parameter is set to 1,00 second a change of 10% in the error value causes the controller output to change by 10.00%/s. If the parameter value is set to 0.00 s the PID controller will operate as PD-controller. See examples below.

2.9.6 PID controller D-time

The parameter 2.9.5 defines the derivation time of the PID controller. If this parameter is set to 1,00 second a change of 10% in the error value during 1.00 s causes the controller output to change by 10.00%. If the parameter value is set to 0.00 s the PID controller will operate as PI-controller. See examples below.

See examples below.

Example 1:

In order to reduce the error value to zero, with the given values, the frequency converter output behaves as follows:

Given values:

Par. 2.9.4, P = 0%	PID max limit = 100.0%
Par. 2.9.5, I-time = 1.00 s	PID min limit = 0.0%
Par. 2.9.6, D-time = 0.00 s	Min freq. = 0 Hz
Error value (setpoint – process value) = 10.00%	Max freq. = 50 Hz

In this example, the PID controller operates practically as ID-controller only. According to the given value of parameter 2.9.5 (I-time), the PID output increases by 5 Hz (10% of the difference between the maximum and minimum frequency) every second until the error value is 0.

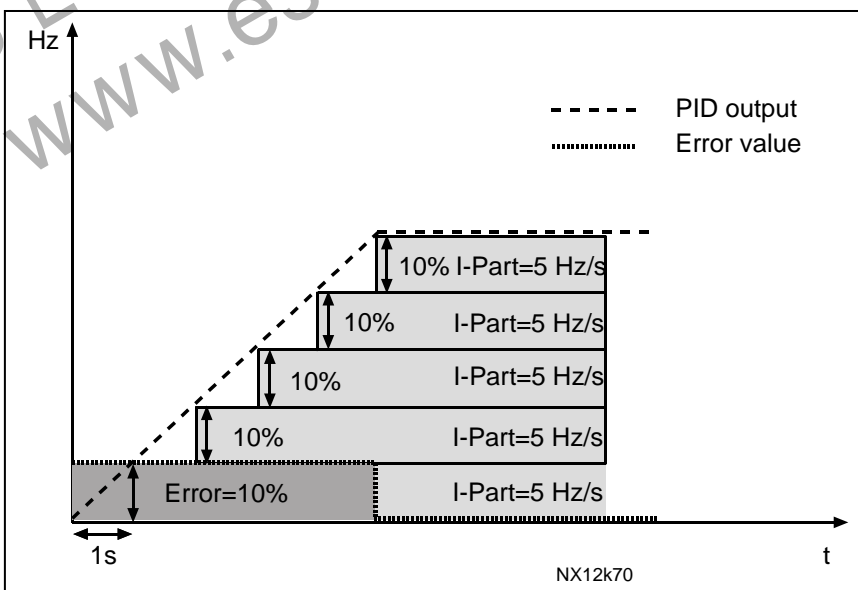

Figure 1- 25. PID controller function as I-controller

Example 2:Given values:

Par. 2.9.4, P = 100%	PID max limit = 100.0%
Par. 2.9.5, I-time = 1.00 s	PID min limit = 0.0%
Par. 2.9.6, D-time = 1.00 s	Min freq. = 0 Hz
Error value (setpoint – process value) = $\pm 10\%$	Max freq. = 50 Hz

As the power is switched on, the system detects the difference between the setpoint and the actual process value and starts to either raise or decrease (in case the error value is negative) the PID output according to the I-time. Once the difference between the setpoint and the process value has been reduced to 0 the output is reduced by the amount corresponding to the value of parameter 2.9.5.

In case the error value is negative, the frequency converter reacts reducing the output correspondingly.

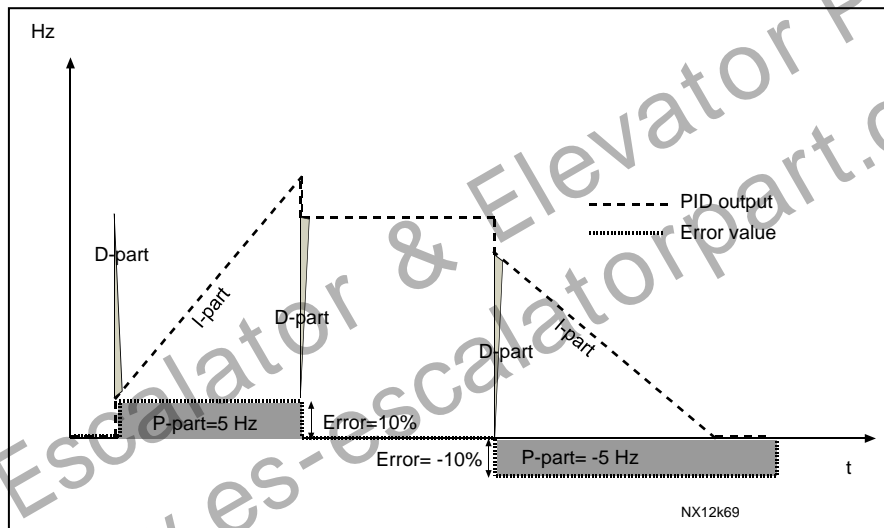

Figure 1-26. PID output curve with the values of Example 2

Example 3:Given values:

Par. 2.9.4, P = 100%	PID max limit = 100.0%
Par. 2.9.5, I-time = 0.00 s	PID min limit = 0.0%
Par. 2.9.6, D-time = 1.00 s	Min freq. = 0 Hz
Error value (setpoint – process value) = $\pm 10\%/s$	Max freq. = 50 Hz

As the error value increases, also the PID output increases according to the set values (D-time = 1.00s).

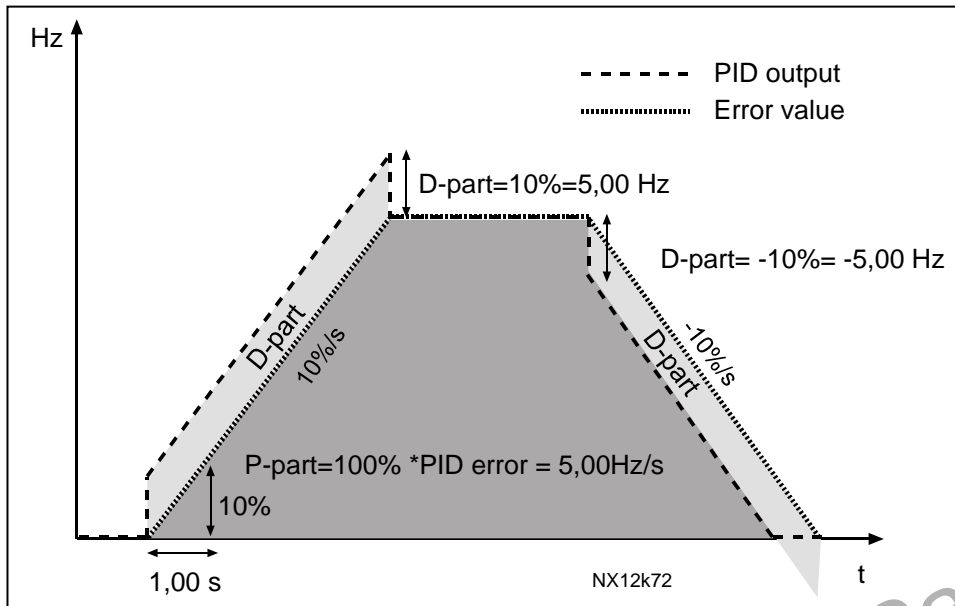

Figure 1- 27. PID output with the values of Example 3.

2.9.7 Actual value 1 minimum scale

Sets the minimum scaling point for Actual value 1. See Figure 1- 28

2.9.8 Actual value 1 maximum scale

Sets the maximum scaling point for Actual value 1. See Figure 1- 28

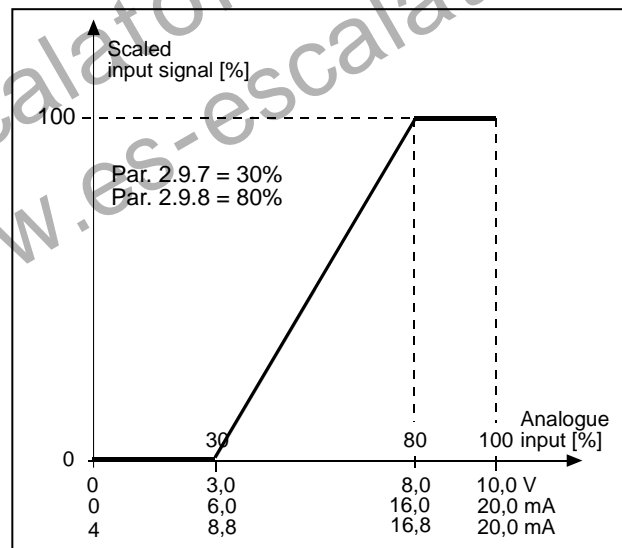

Figure 1- 28. Example of actual value signal scaling

2.9.9 PID error value inversion

This parameter allows you to invert the error value of the PID controller (and thus the operation of the PID controller).

- 0 No inversion
- 1 Inverted

2.9.10 Sleep frequency

The frequency converter is stopped automatically if the frequency of the drive falls below the Sleep level defined with this parameter for a time greater than that determined by [parameter 2.9.11](#). During the Stop state, the PID controller is operating switching the frequency converter to Run state when the actual value signal either falls below or exceeds (see par. 2.9.13) the Wake-up level determined by parameter 2.9.12. See Figure 1- 29

2.9.11 Sleep delay

The minimum amount of time the frequency has to remain below the Sleep level before the frequency converter is stopped. See Figure 1- 29

2.9.12 Wake-up level

The wake-up level defines the frequency below which the actual value must fall or which has to be exceeded before the Run state of the frequency converter is restored. See Figure 1- 29

2.9.13 Wake-up function

This parameter defines if the restoration of the Run state occurs when the actual value signal falls below or exceeds the *Wake-up level* (par. 2.9.12). See Figure 1- 29 and Figure 1- 30

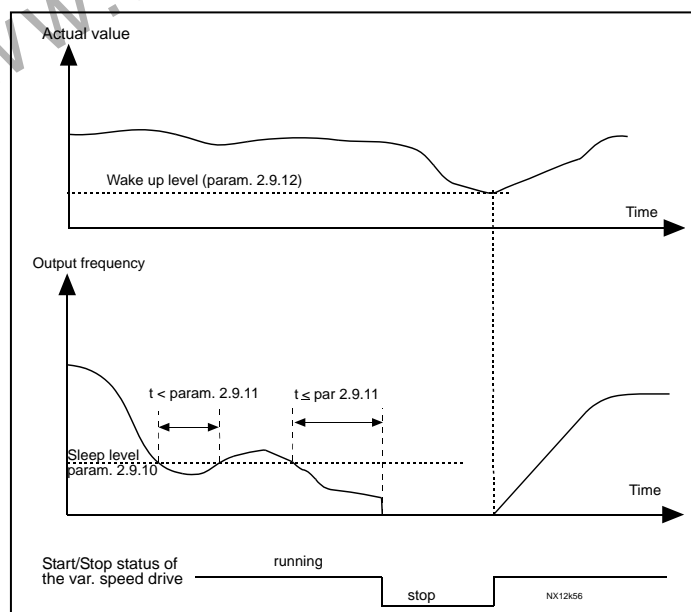

Figure 1- 29. Frequency converter sleep function

Par. value	Function	Limit	Description
0	Wake-up happens when actual value goes below the limit	The limit defined with parameter 2.9.12 is in percent of the maximum actual value	
1	Wake-up happens when actual value exceeds the limit	The limit defined with parameter 2.9.12 is in percent of the maximum actual value	
2	Wake up happens when actual value goes below the limit	The limit defined with parameter 2.9.12 is in percent of the current value of the reference signal	
3	Wake up happens when actual value exceeds the limit	The limit defined with parameter 2.9.12 is in percent of the current value of the reference signal	

NXLk59.fh8

Figure 1- 30. Selectable wake-up functions

4.10 PUMP AND FAN CONTROL

The Pump and Fan Control can be used to control one variable speed drive and up to 3 auxiliary drives. The PID controller of the frequency converter controls the speed of the variable speed drive and gives control signals to start and stop the auxiliary drives to control the total flow. In addition to the eight parameter groups provided as standard, a parameter group for multi-pump and fan control functions is available.

As already its name tells, the Pump and Fan Control is used to control the operation of pumps and fans. The application utilizes external contactors for switching between the motors connected to the frequency converter. The autochange feature provides the capability of changing the starting order of the auxiliary drives.

4.10.1 Short description of PFC function and essential parameters

Automatic changing between drives (Autochange & Interlockings selection, P2.10.4)

The automatic change of starting and stopping order is activated and applied to either the auxiliary drives only or the auxiliary drives **and** the drive controlled by the frequency converter depending on the setting of parameter 2.10.4.

The *Autochange function* allows the starting and stopping order of drives controlled by the pump and fan automatics to be changed at desired intervals. The drive controlled by frequency converter can also be included in the automatic changing and locking sequence (par 2.10.4). The Autochange function makes it possible to equalize the run times of the motors and to prevent e.g. pump stalls due to too long running breaks.

- Apply the Autochange function with parameter 2.10.4, *Autochange*.
- The autochange takes place when the time set with parameter 2.10.5 *Autochange interval*, has expired and the capacity used is below the level defined with parameter 2.10.7, *Autochange frequency limit*.
- The running drives are stopped and re-started according to the new order.
- External contactors controlled through the relay outputs of the frequency converter connect the drives to the frequency converter or to the mains. If the motor controlled by the frequency converter is included in the autochange sequence, it is always controlled through the relay output activated first. The other relays activated later control the auxiliary drives

This parameter is used to activate the interlock inputs (Values 3 & 4). The interlocking signals come from the motor switches. The signals (functions) are connected to digital inputs which are programmed as interlock inputs using the corresponding parameters. The pump and fan control automatics only control the motors with active interlock data.

- If the interlock of an auxiliary drive is inactivated and another unused auxiliary drive available, the latter will be put to use without stopping the frequency converter.
- If the interlock of the controlled drive is inactivated, all motors will be stopped and re-started with the new set-up.
- If the interlock is re-activated in Run status, the automatics will stop all motors immediately and re-start with a new set-up. Example: $[P1 \rightarrow P3] \rightarrow [P2 \text{ LOCKED}] \rightarrow [STOP] \rightarrow [P1 \rightarrow P2 \rightarrow P3]$

See Chapter 4.10.2, Examples.

Parameter 2.10.5, Autochange interval

After the expiry of the time defined with this parameter, the autochange function takes place if the capacity used lies below the level defined with parameters 2.10.7 (*Autochange frequency limit*) and 2.10.6 (*Maximum number of auxiliary drives*). Should the capacity exceed the value of par 2.10.7, the autochange will not take place before the capacity goes below this limit.

- The time count is activated only if the Start/Stop request is active.
- The time count is reset after the autochange has taken place or on removal of Start request

Parameters 2.10.6, Maximum number of auxiliary drives and 2.10.7, Autochange frequency limit

These parameters define the level below which the capacity used must remain so that the autochange can take place.

This level is defined as follows:

- If the number of running auxiliary drives is smaller than the value of parameter 2.10.6 the autochange function can take place.
- If the number of running auxiliary drives is equal to the value of parameter 2.10.6 and the frequency of the controlled drive is below the value of parameter 2.10.7 the autochange can take place.
- If the value of parameter 2.10.7 is 0.0 Hz, the autochange can take place only in rest position (Stop and Sleep) regardless of the value of parameter 2.10.6.

4.10.2 Examples

PFC with interlocks and autochange between 3 pumps (OPT-AA or OPT-B5 option board required)

Situation: 1 controlled drive and 2 auxiliary drives.
 Parameter settings: 2.10.1= 2

Interlock feedback signals used, autochange between all drives used.
 Parameter settings: 2.10.4=4
 DIN4 active (par.2.2.6=0)

The interlock feedback signals come from the digital inputs DIN4 (AI1), DIN2 & DIN3 selected with parameters 2.1.17, 2.1.18 and 2.2.4.

The control of pump 1 (par.2.3.1=17) is enabled through Interlock 1 (DIN2, 2.1.17=10), the control of pump 2 (par.2.3.2=18) through Interlock 2 (DIN3, par. 2.1.18=13) and the control of pump 3 (par.2.3.3=19) through Interlock 3 (DIN4)

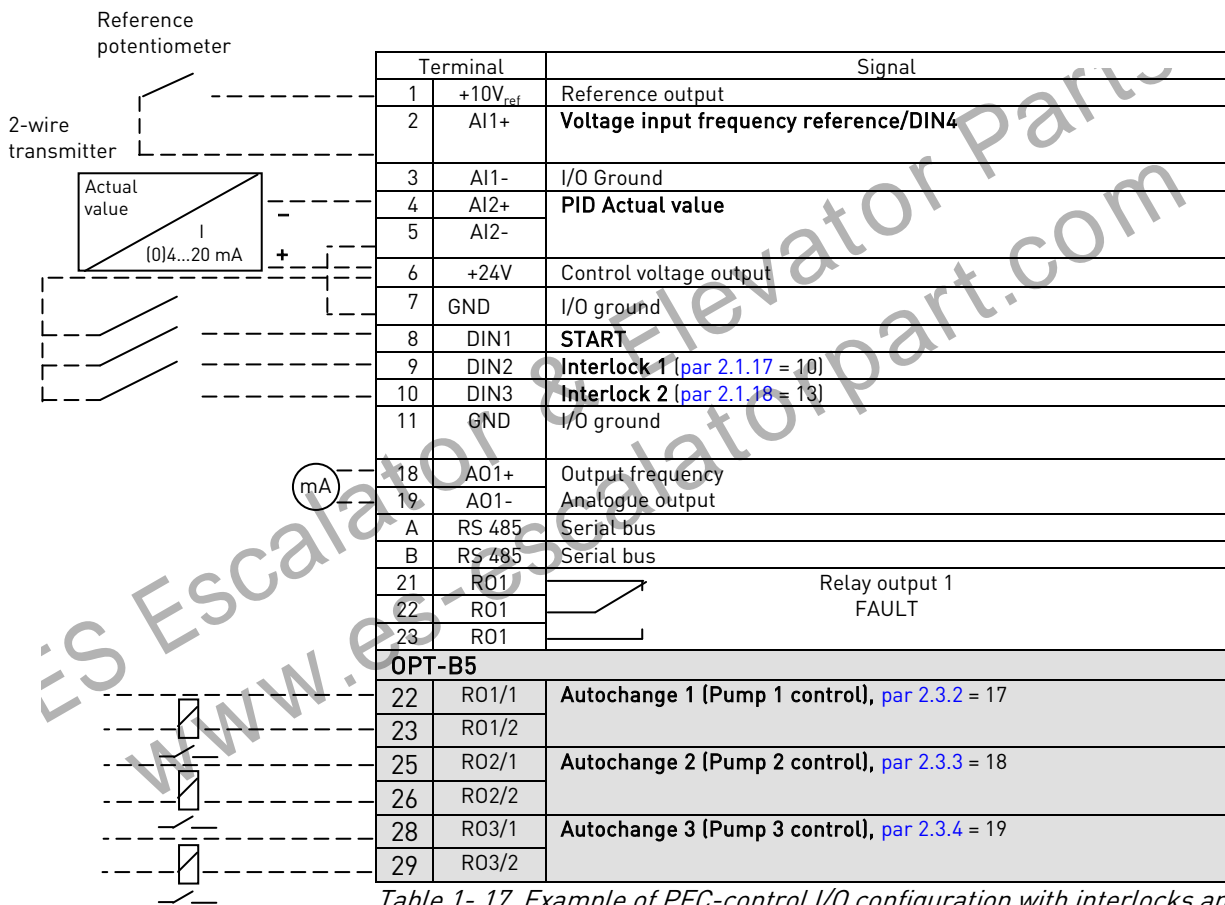

Table 1- 17. Example of PFC-control I/O configuration with interlocks and autochange between 3 pumps

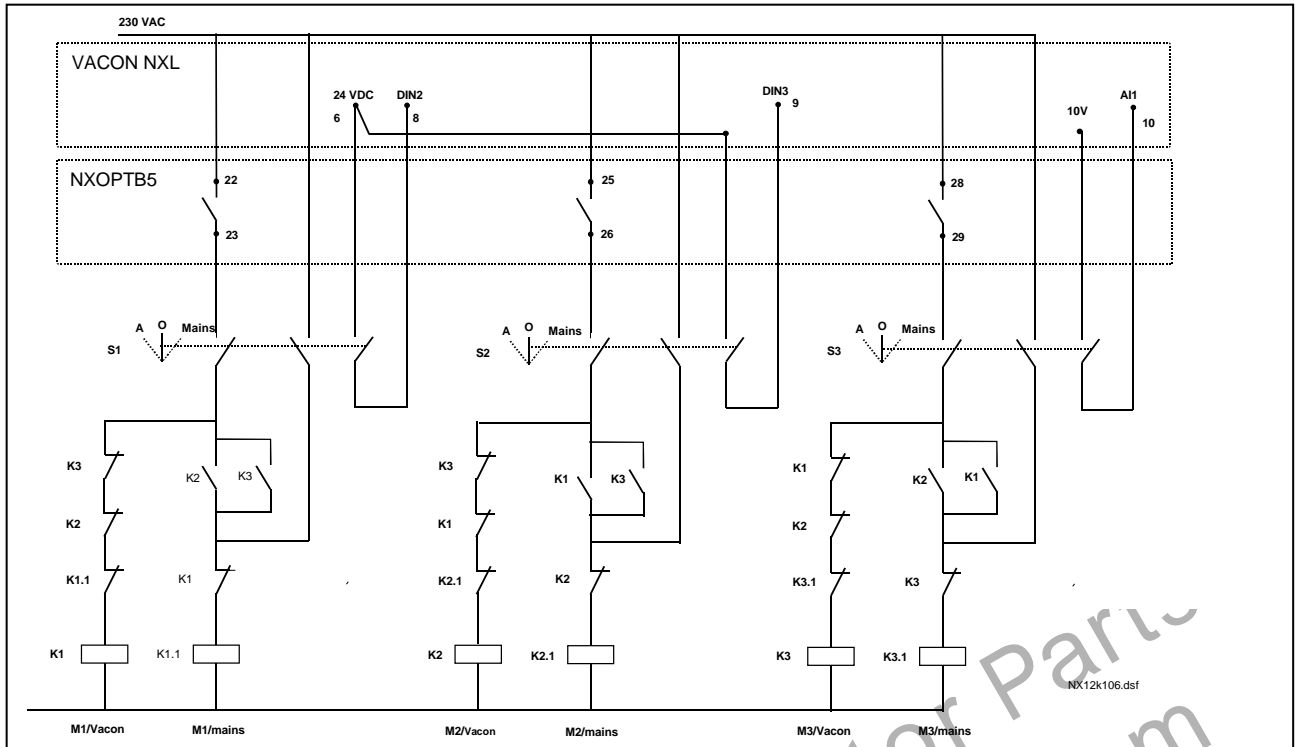

Figure 1- 31. 3-pump autochange system, principal control diagram

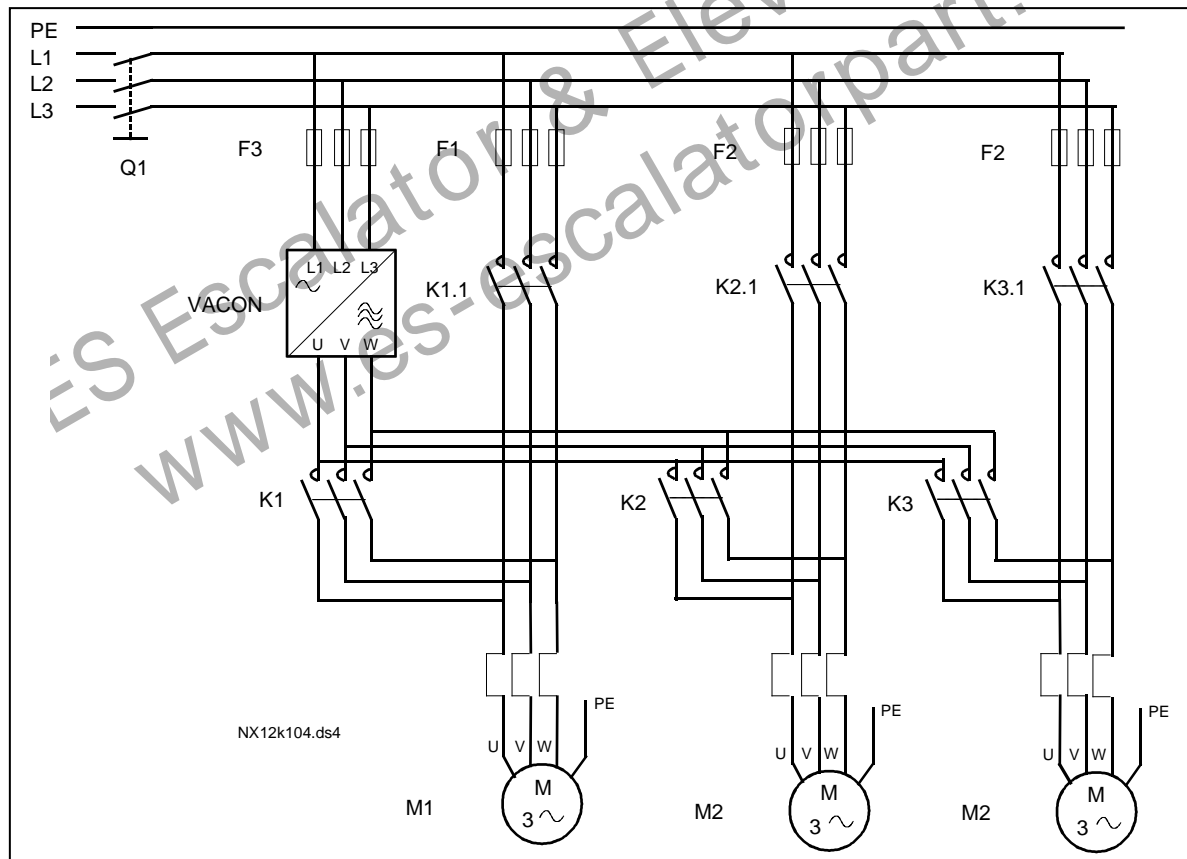

Figure 1- 32. Example of 3-pump autochange, main diagram

PFC with interlocks and autochange between 2 pumps (OPT-AA or OPT-B5 option board required)

Situation: 1 controlled drive and 1 auxiliary drive.

Parameter settings: 2.10.1= 1

Interlock feedback signals used, autochange between pumps used.

Parameter settings: 2.10.4=4

The interlock feedback signals come from the digital input DIN2 (par. 2.1.17) and digital input DIN3, (par. 2.1.18).

The control of pump 1 (par.2.3.1=17) is enabled through Interlock 1 (DIN2, P2.1.17), the control of pump 2 (par.2.3.2=18) through Interlock 2 (par. 2.1.18=13)

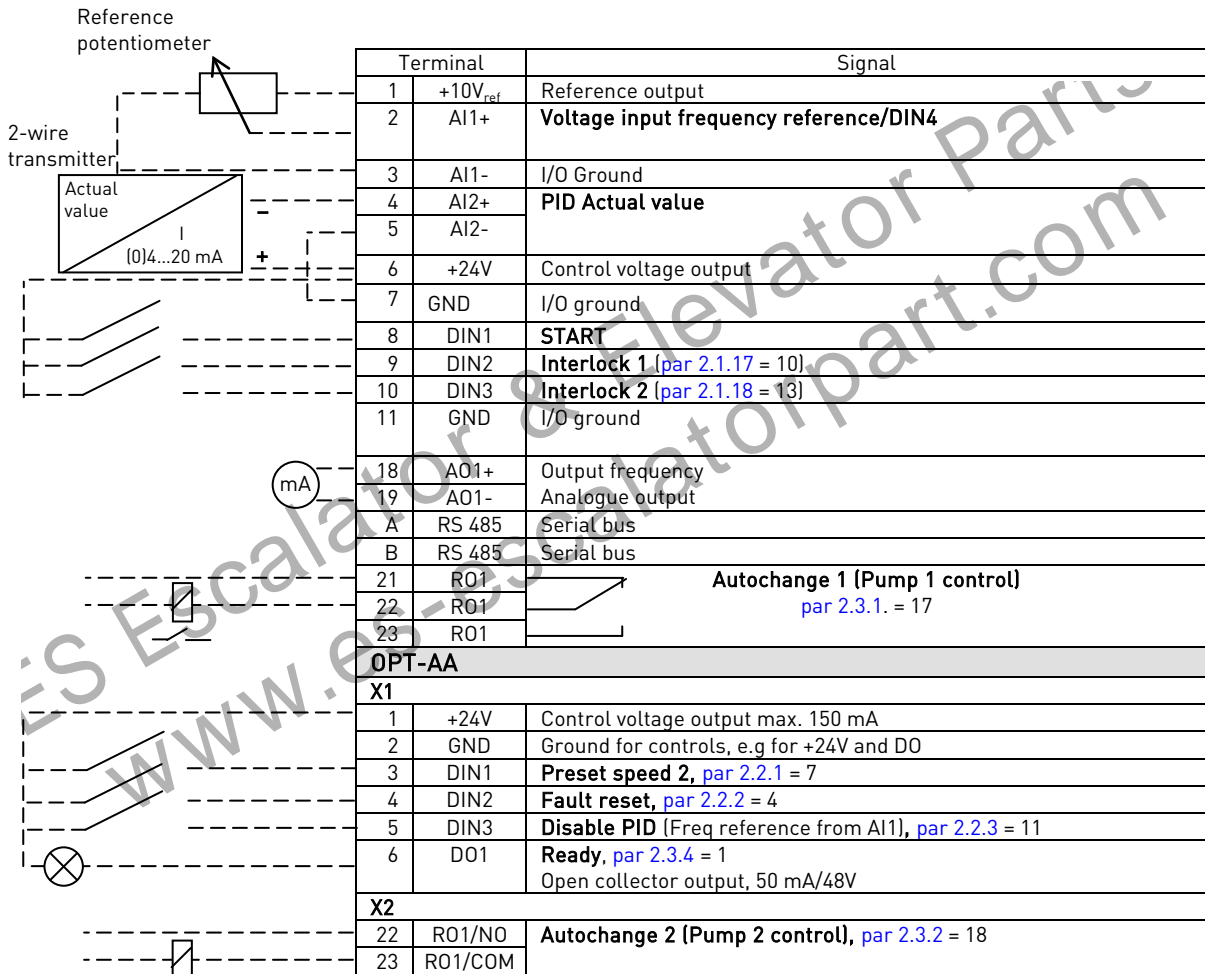

Table 1- 18. Example of PFC-control I/O configuration with interlocks and autochange between 2 pumps

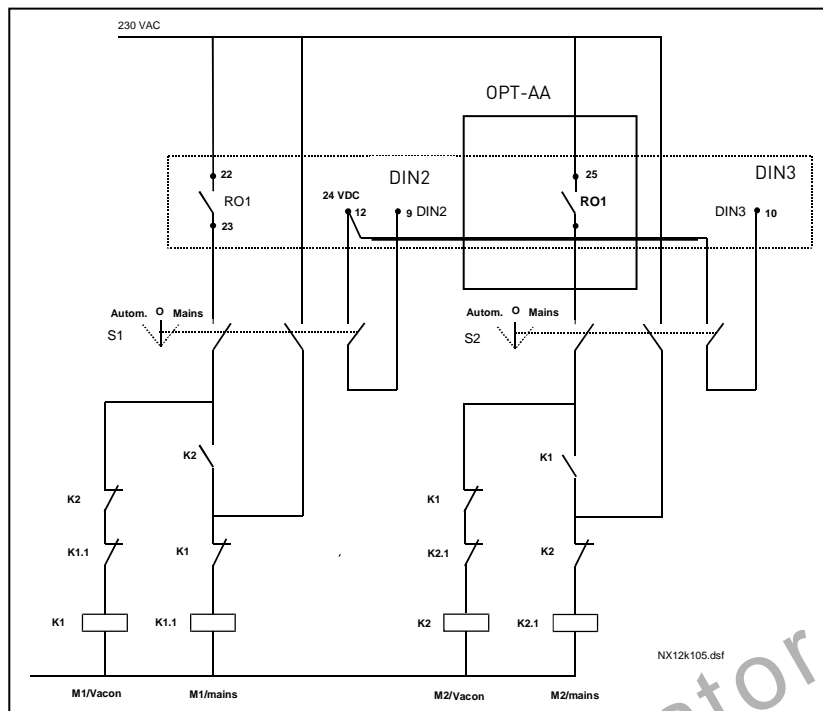

Figure 1- 33. 2-pump autochange system, principal control diagram

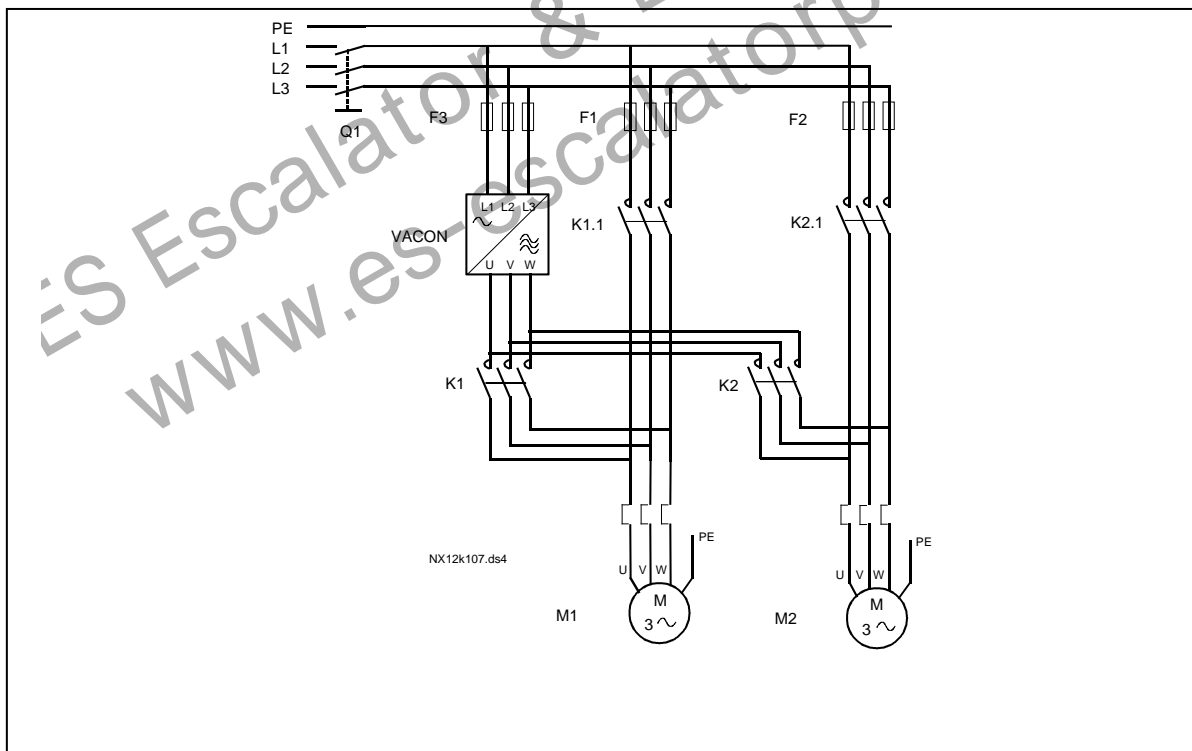

Figure 1- 34. Example of 2-pump autochange, main diagram

4.10.3 Description of Pump and Fan control parameters

2.10.1 Number of auxiliary drives

With this parameter the number of auxiliary drives in use will be defined. The functions controlling the auxiliary drives (parameters 2.10.4 to 2.10.7) can be programmed to relay outputs.

2.10.2 Start delay of auxiliary drives

The frequency of the drive controlled by the frequency converter must remain above the maximum frequency for the time defined with this parameter before the auxiliary drive is started. The delay defined applies to all auxiliary drives. This prevents unnecessary starts caused by momentary start limit exceedings..

2.10.3 Stop delay of auxiliary drives

The frequency of the drive controlled by the frequency converter must remain below the minimum frequency for the time defined with this parameter before the drive is stopped. The delay defined applies to all auxiliary drives. This prevents unnecessary stops caused by momentary falls below the stop limit.

2.10.4 Automatic changing between drives

0= Not used

1= Autochange with aux pumps

The drive controlled by the frequency converter remains the same. Therefore, mains contactor is needed for one auxiliary drive only.

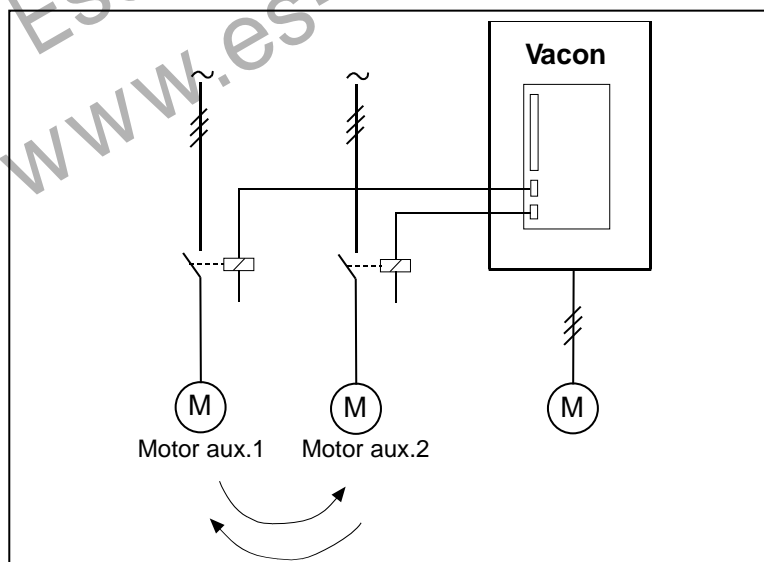

Figure 1- 35. Autochange applied to auxiliary drives only.

2= Autochange with frequency converter and auxiliary pumps

The drive controlled by the frequency converter is included in the automatics and a contactor is needed for each drive to connect it to either the mains or the frequency converter

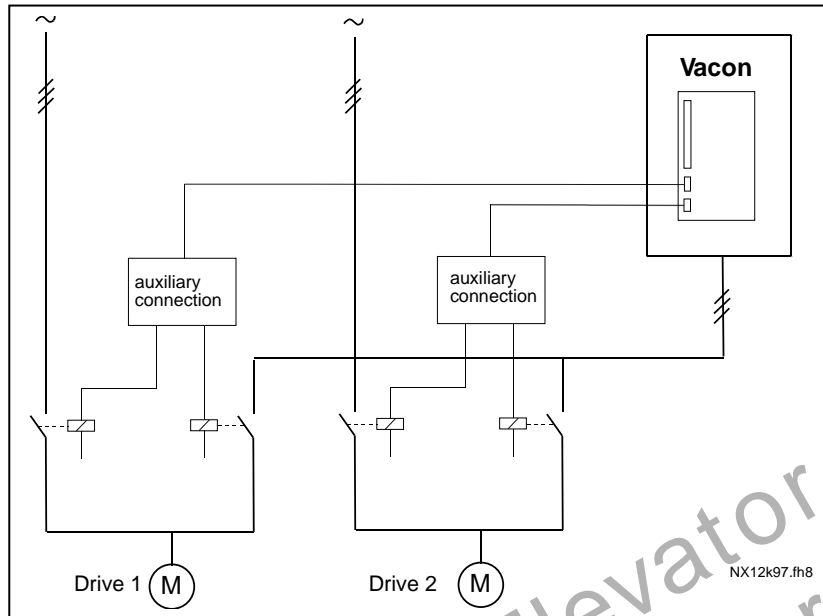

Figure 1- 36. Autochange with all drives

3= Autochange and interlocks (only auxiliary pumps)

The drive controlled by the frequency converter remains the same. Therefore, mains contactor is needed for one auxiliary drive only. Interlocks for autochange outputs 1, 2, 3 (or DIE1,2,3) can be selected with par. 2.1.17 and 2.1.18.

4= Autochange and interlocks (Freq. conv & aux pumps)

The drive controlled by the frequency converter is included in the automatics and a contactor is needed for each drive to connect it to either the mains or the frequency converter. DIN 1 is automatically intelock for Autochange output 1. Interlocks for Autochange output 1, 2, 3 (or DIE1,2,3) can be selected with par. 2.1.17 and 2.1.18.

2.10.5 Autochange interval

After the expiry of the time defined with this parameter, the autochange function takes place if the capacity used lies below the level defined with parameters 2.10.7 (*Autochange frequency limit*) and 2.10.6 (*Maximum number of auxiliary drives*). Should the capacity exceed the value of P2.10.7, the autochange will not take place before the capacity goes below this limit.

- The time count is activated only if the Start/Stop request is active.
- The time count is reset after the autochange has taken place or on removal of Start request

2.10.6 *Maximum number of auxiliary drives***2.10.7** *Autochange frequency limit*

These parameters define the level below which the capacity used must remain so that the autochange can take place.

This level is defined as follows:

- If the number of running auxiliary drives is smaller than the value of parameter 2.10.6 the autochange function can take place.
- If the number of running auxiliary drives is equal to the value of parameter 2.10.6 and the frequency of the controlled drive is below the value of parameter 2.10.7 the autochange can take place.
- If the value of parameter 2.10.7 is 0.0 Hz, the autochange can take place only in rest position (Stop and Sleep) regardless of the value of parameter 2.10.6.

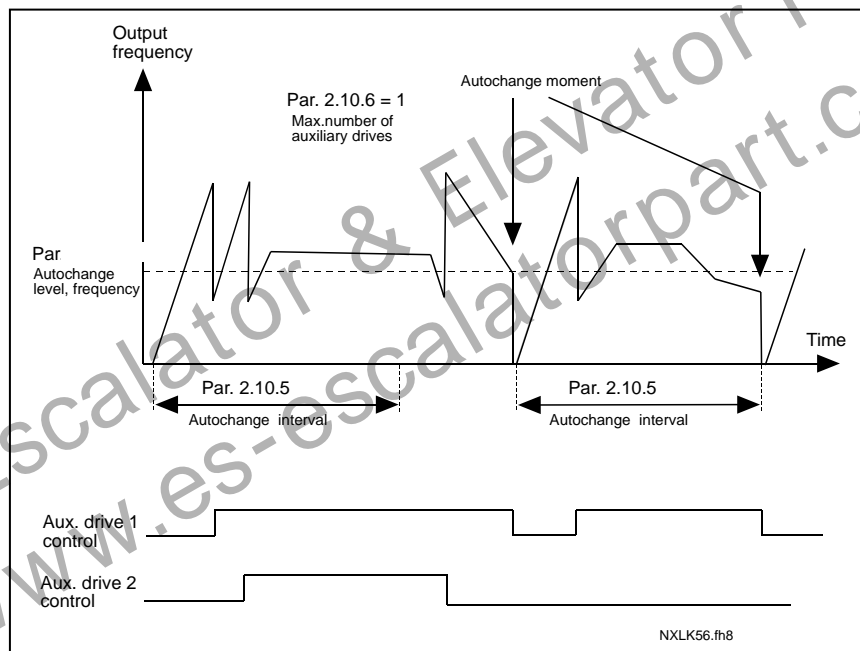

Figure 1- 37. Autochange interval and limits

2.10.8 *Start frequency, auxiliary drive 1*

The frequency of the drive controlled by the frequency converter must exceed the limit defined with these parameters with 1 Hz before the auxiliary drive is started. The 1 Hz overdrift makes a hysteresis to avoid unnecessary starts and stops. See also parameters 2.1.1 and 2.1.2.

2.10.9 *Stop frequency, auxiliary drive 1*

The frequency of the drive controlled by the frequency converter must fall with 1Hz below the limit defined with these parameters before the auxiliary drive is stopped. The stop frequency limit also defines the frequency to which the frequency of the drive controlled by the frequency converter is dropped after starting the auxiliary drive.

4.11 KEYPAD CONTROL PARAMETERS

3.1 *Control place*

The active control place can be changed with this parameter. For more information, see Vacon NXL User's Manual, Chapter 7.4.3.

3.2 *Keypad reference*

The frequency reference can be adjusted from the keypad with this parameter. For more information, see Vacon NXL User's Manual, Chapter 7.4.3.2.

3.3 *Keypad direction*

- 0 Forward: The rotation of the motor is forward, when the keypad is the active control place.
- 1 Reverse: The rotation of the motor is reversed, when the keypad is the active control place.

For more information, see Vacon NXL User's Manual, Chapter 7.4.3.3.

3.4 *Stop button activated*

If you wish to make the Stop button a "hotspot" which always stops the drive regardless of the selected control place, give this parameter the value 1 (default). See Vacon NXL User's Manual, Chapter 7.4.3.

See also parameter 3.1.

3.5 *PID reference 1*

The PID controller keypad reference can be set between 0% and 100%. This reference value is the active PID reference if parameter 2.9.2 = 2.

3.6 *PID reference 2*

The PID controller keypad reference 2 can be set between 0% and 100%. This reference is active if the DIN# function=12 and the DIN# contact is closed.

5. CONTROL SIGNAL LOGIC

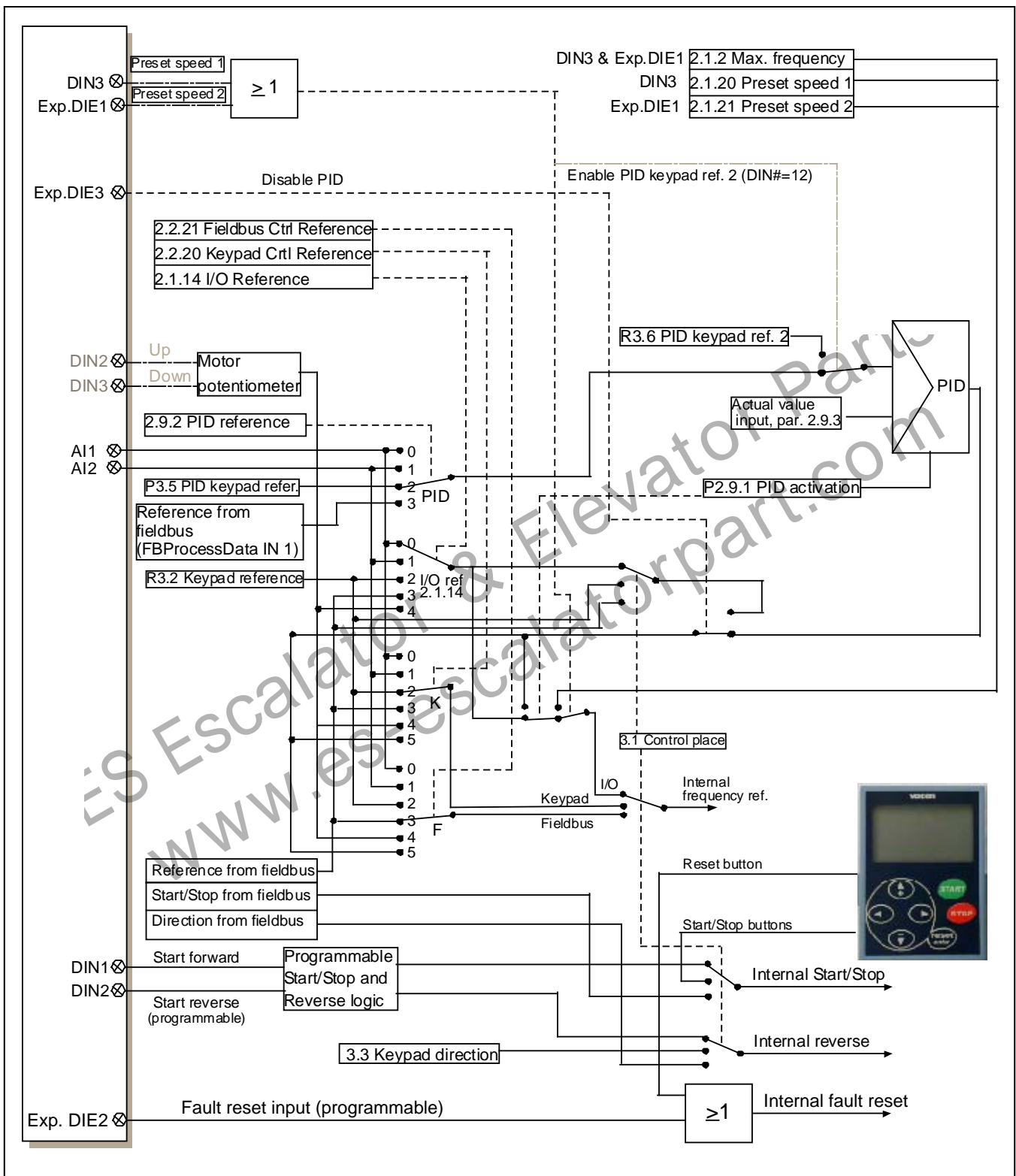

Figure 1- 38. Control signal logic of the Multi-Control Application